

KOGANEI

Pulse Blow Series Offers Energy Savings for Air-blowing Procedures

Compressed air is not free!!

Reduce compressed air use by **nearly 50%**

No
Electricity
required

Generates pulsed air without using electricity!



Pulse blow air gun PAG series

NEW PAU series
Large flow volume type



Pulse blow unit PAU series

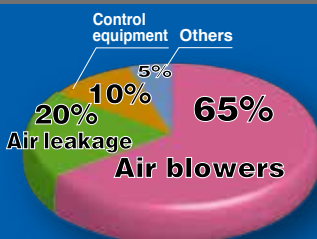

Measures to reduce factory air consumption!

Air compressors are said to use about 20% of a factory's overall electric power. About **65%** of that compressed air is usually consumed by blowing air. Pulse blow air gun can reduce the amount of compressed air consumption and help save energy.

Compressed air is not free!!

Reduce compressed air use
by **nearly 50%**

The first in the world!

Pulse blow air gun **PAG series** PAT. PEND.

No electricity required!
Built-in pulse air generator



Trimmer:
Pulse frequency can
be adjusted with flat
blade screwdriver

Lightweight design
194 g [6.84 oz]

Main unit only

No electricity required
Valve is built-in

Built-in pulse air generator
Just hook up compressed air

Nozzle variations
Air amplifier nozzle



- Air volume is about 4.5 times (consumed flow is same as standard ϕ 3 [0.118 in] nozzle)
- Standard nozzle orifice diameter ϕ 2 mm [0.079 in], ϕ 3 mm [0.118 in], ϕ 4 mm [0.157 in]
- Long nozzle (orifice diameter ϕ 2.3 [0.091 in]) 150 mm [5.906 in], 200 mm [7.874 in]

Merits of pulse blowing

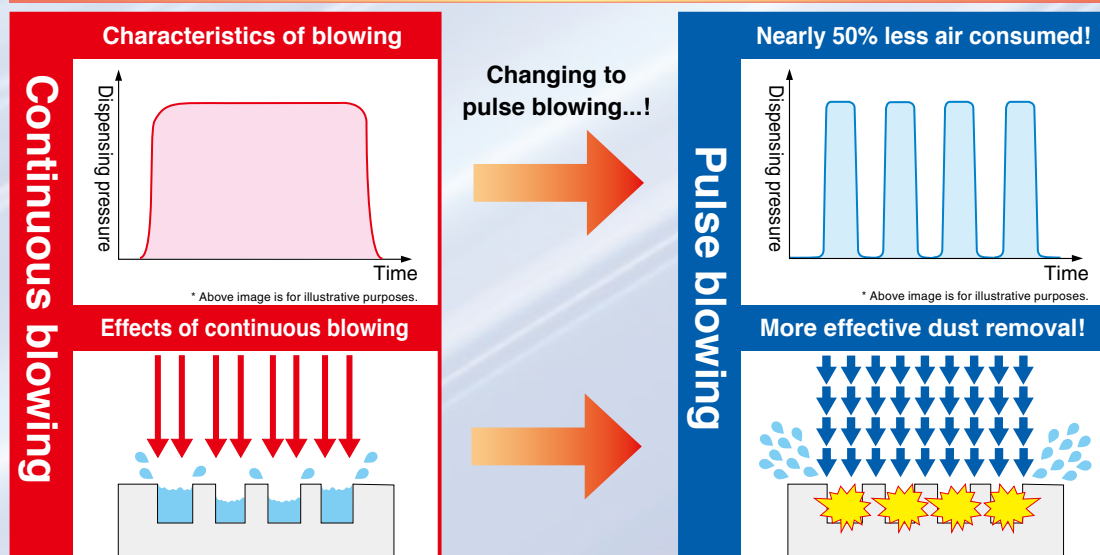

More effective dust removal!!

Pulsed blown air provides more effective dust removal, by intermittently applying blasts to an object to remove dust, compared to continuously blowing air.

Pulse blow unit PAU series



No electricity required!

Just attach a pulse blow unit to your air gun to use it as a pulse blow air gun.



Lightweight design
73 g [2.58 oz]

Main unit: Aluminum

Mountable

Can be mounted and used in air blowing procedures by installing additional mounting bracket.



NEW Large flow rate type



Direct mounting type

Double the flow rate!!

- Doubled the flow volume for an **enhanced performance of dust removal** compared to PAU!
- Improved space economy by a volume of **130% (compared to PAU)** despite giving 2 times the flow!
- Direct mounting **streamlines installation on your equipment!**

Brackets not required

Pulse blow air gun

PAG series



Specifications

Model		PAG - □
Item		
Medium		Air
Lubrication		No
Operating pressure range	MPa [psi]	0.35 to 0.7 [51 to 102]
Operating temperature range	°C [°F]	5 to 50 [41 to 122]
Pulse frequency range	Hz	5 to 15
Port size		Piping side: Rc 1/4 (G1/4 when -F21 is selected), nozzle side: G1/8
Nozzle diameter	mm [in]	Standard nozzle: ϕ 2 [0.079], ϕ 3 [0.118], ϕ 4 [0.157]/ long nozzle: ϕ 2.3 [0.091]/air amplifier nozzle ϕ 3 [0.118])
Weight	g [oz]	194 [6.84] (main unit only)
Material	Main unit cover	PBT resin
	Lever	POM resin

Note 1: Air that is used should be clean air that contains no oil or foreign matter, etc.

If liquid or dust gets into the pulse blow air gun, it may cause defective operation.

Note 2: Nozzle is equipped when shipped. Wrap sealing tape around threads of the nozzle when assembling it.

Note 3: This product uses grease internally.

Order Codes

● Main unit

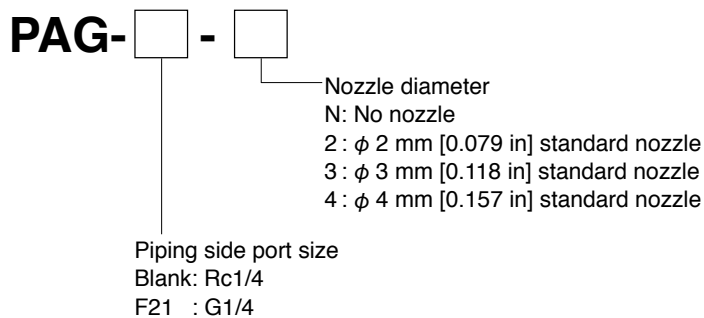

● Additional parts (individual nozzles)

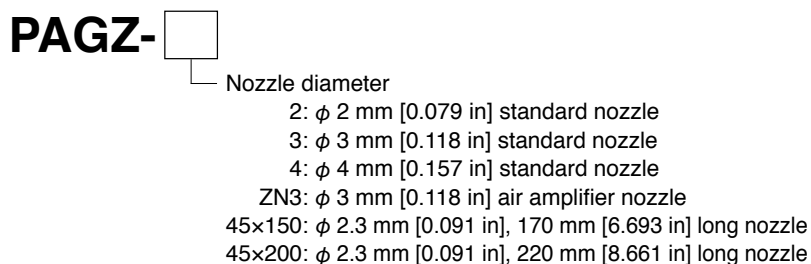

(Standard nozzle)



(Air amplifier nozzle)



(Long nozzle)



Dimensions mm [in]

● Main unit PAG-□

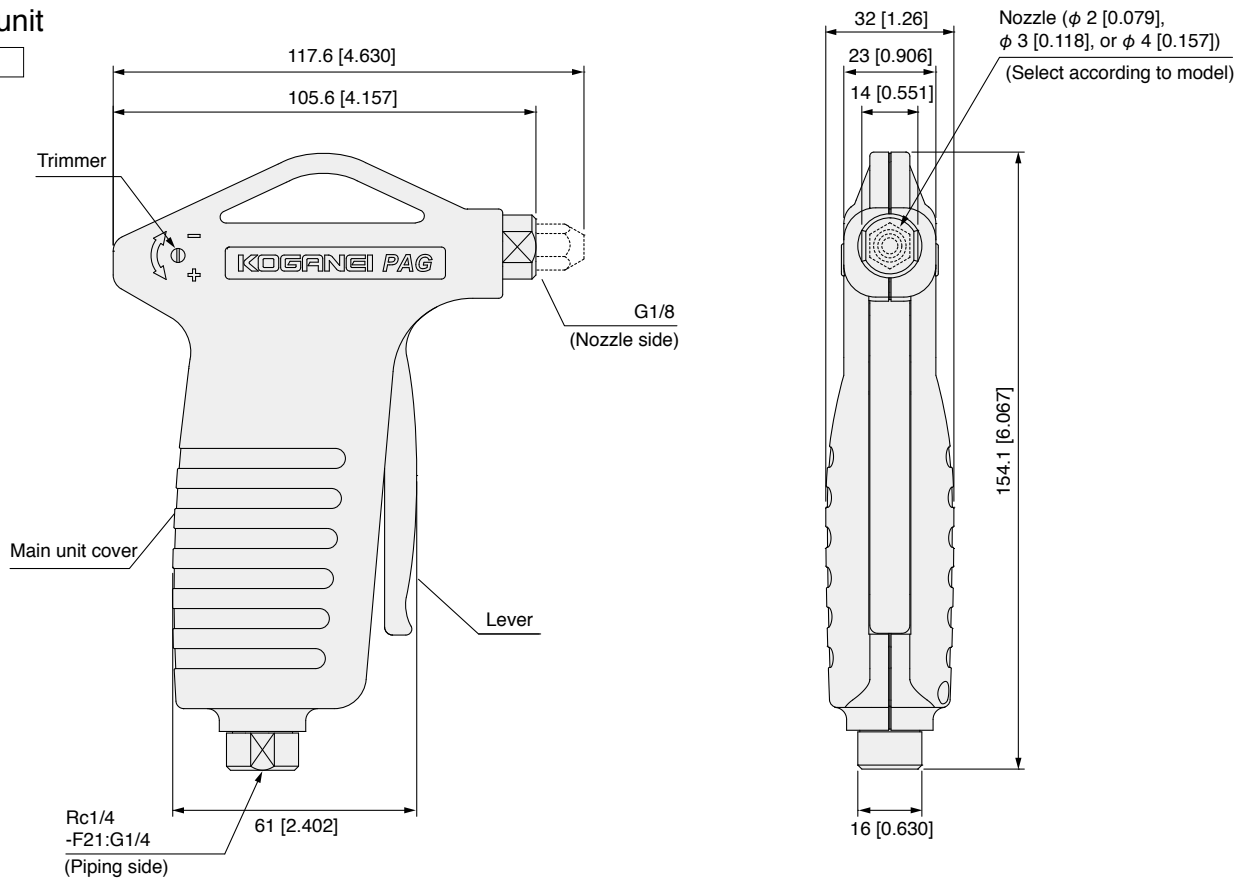

● Standard nozzle identifiers

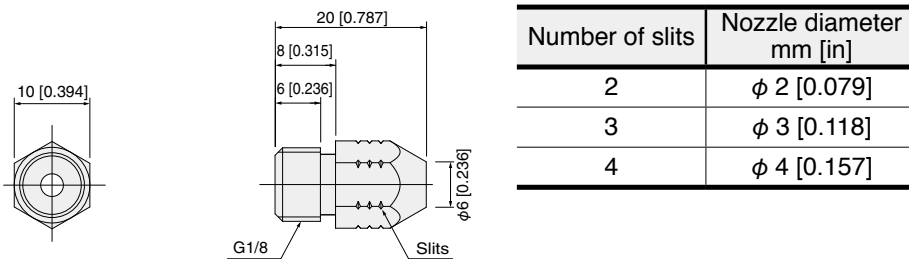

● Long nozzle

PAGZ-45x□

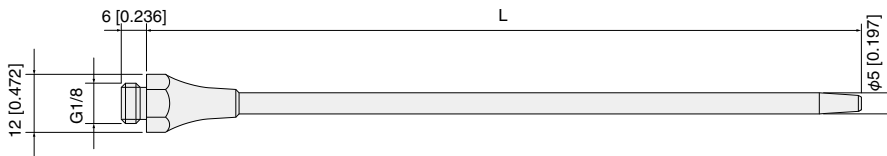

Model	L mm [in]
PAGZ-45×150	170 [6.693]
PAGZ-45×200	220 [8.661]

● Air amplifier nozzle

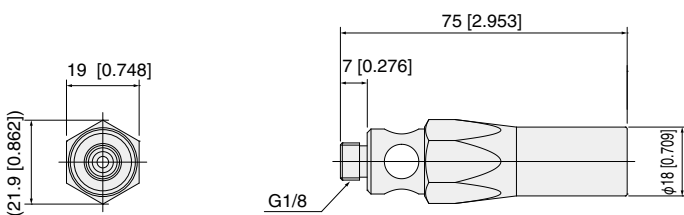

Operation principles

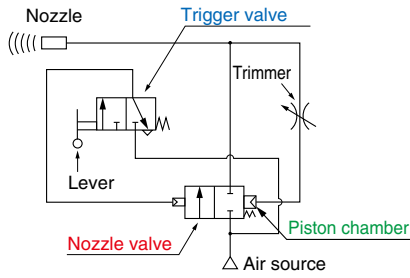

1. Pulling the lever sends a signal from the **trigger valve** to open the **pulse valve**.
 2. The **pulse valve** opens, and air is output from the nozzle.
 3. Some of the air that is output from the **pulse valve** goes through the trimmer to accumulate in the **piston chamber**.
 4. When some air has accumulated, the **pulse valve** closes so that air output from the nozzle stops and at the same time the air in the **piston chamber** is exhausted.
 5. A certain amount of air is exhausted from the **piston chamber**, the **pulse valve** opens again, and air is output from the nozzle.
- Steps 3 to 5 are then repeated
 *The pulse frequency can be adjusted by using the trimmer

Frequency adjustment method

The pulse frequency can be adjusted by rotating the frequency adjustment trimmer, as shown in the figure at right.

Use a small flat blade screwdriver for adjustments.

Toward + (counterclockwise): Increases frequency.

Toward - (clockwise): Decreases frequency.

Note: Turning the trimmer counterclockwise raises the frequency and turning it clockwise lowers the frequency. However, turning the trimmer further than needed, after fully opening or closing it, may damage component parts.

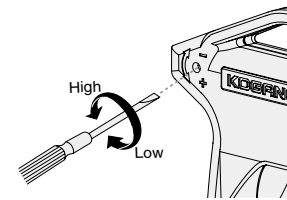

Characteristics of the frequency and flow according to the number of rotations of the trimmer (standard nozzle)

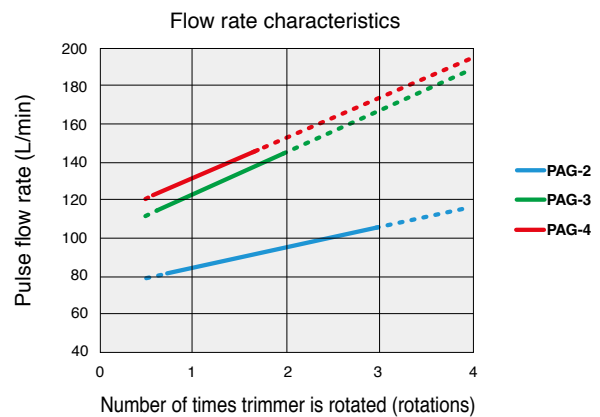
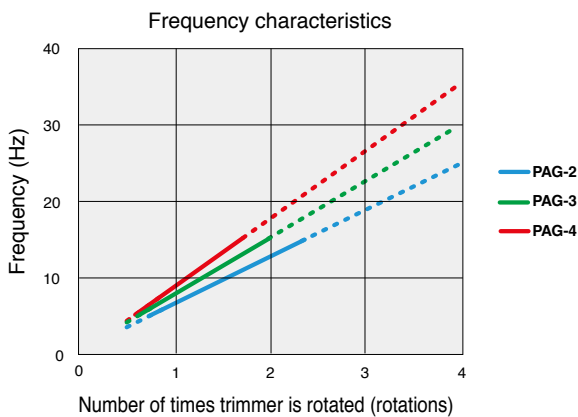

Note 1: According to Koganei testing conditions ①.

Note 2: The characteristics of the frequency and the flow vary depending on the usage and piping conditions.

Note 3: Use devices within the pulse frequency ranges (5 to 15 Hz) shown in the specification charts.

Note 4: Contact us regarding the long nozzle and air amplifier nozzle.

Testing conditions ①

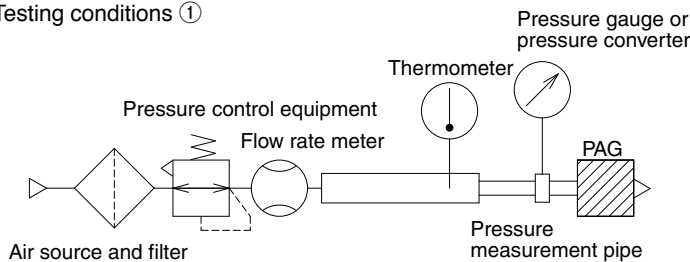

Operations according to piping conditions for pulse blow air guns (standard nozzle)

Operations may be unstable, depending on the piping conditions on the supply side. See the following table.

Model	Operating pressure	φ 6 [0.236] tube			φ 8 [0.315] tube		
		1000 mm [39.370 in]	3000 mm [118.110 in]	5000 mm [196.850 in]	1000 mm [39.370 in]	3000 mm [118.110 in]	5000 mm [196.850 in]
PAG-2	0.35 MPa [51 psi]	○	○	○	○	○	○
	0.5 MPa [73 psi]	○	○	○	○	○	○
	0.7 MPa [102 psi]	○	○	○	○	○	○
PAG-3	0.35 MPa [51 psi]	○	×	×	○	○	○
	0.5 MPa [73 psi]	○	×	×	○	○	○
	0.7 MPa [102 psi]	○	○	×	○	○	○
PAG-4	0.35 MPa [51 psi]	○	×	×	○	○	○
	0.5 MPa [73 psi]	○	×	×	○	○	○
	0.7 MPa [102 psi]	○	×	×	○	○	○

Testing conditions ②

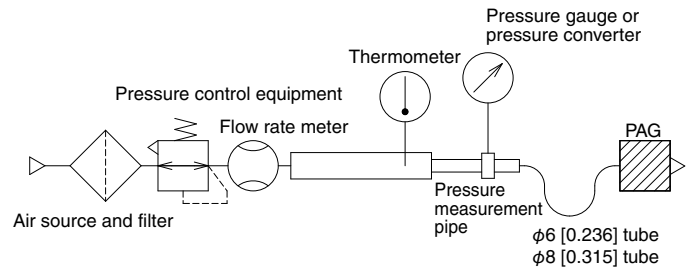

Note 1: ○ indicates stable operations and × indicates unstable operations (according to Koganei testing conditions ②)

Note 2: Operations will be unstable if the piping conditions cause pressure drops or insufficient flow.

Note 3: Contact us regarding the long nozzle and air amplifier nozzle.

Handling precautions

WARNING

- Do not point the tip of the nozzle at people.
- Use safety glasses and earplugs because blowing air could blow objects into people's eyes or cause hearing loss.
- Install a cutoff valve on the IN port side to ensure safety in case of leaks or damage.

CAUTION

- Air containing oil or solids cannot be used. Use cleaned air for the medium (filtered to 40 μm or finer). If liquid or dust gets into the product, it may cause defective operation.
- Pass the medium through a device, such as a freeze-type air dryer or after cooler, to lower the dew-point temperature of the medium to below the ambient temperature so condensation or frost does not occur when the products are blowing.
- Use the product within the pulse frequency ranges shown in the specification charts.
- This product operates on a balance of pressure, so supply enough pressure and volume to keep the pulse operation steady.
- Use an appropriate size wrench to tighten the supply port piping and the nozzle to within the torque range shown below.

Supply side recommended tightening torque:

7 to 9 N·m [5.163 to 6.638 ft·lbf]

Nozzle side recommended tightening torque:

12 to 14 N·m [8.851 to 10.326 ft·lbf]

- Use tubing with an exterior that is not damaged. Do not allow tubing to become severely bent or twisted near the supply port. Doing so could cause air leakage.
- If you leave the product in a location where there is a lot of dust in the air, it could get inside the product and cause erratic operation.

- Do not subject the tip of the nozzle to excessive force. Doing so could result in damage.
- Applying pressure from the nozzle side could cause unstable operation or damage.
- Do not drop, step on, or bump the product. Doing so could result in damage.
- After using the product, put it on a hook or something to store it. Hooking it by the lever may cause defective operation or damage.

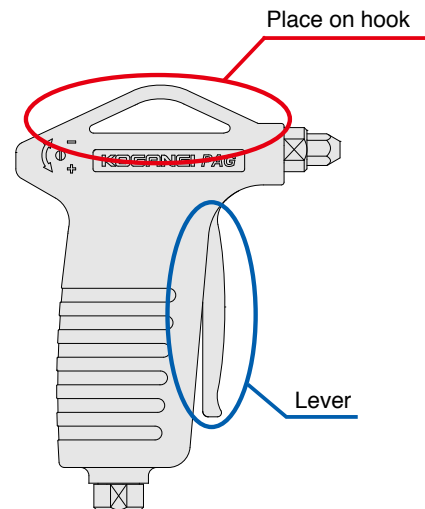

CAUTION *Read the safety precautions on the general catalog homepage before using this product.

Pulse blow unit

PAU-F11 series



Specifications

Model		PAU-F11
Item		Air
Operating pressure range	MPa [psi]	0.35 to 0.7 [51 to 102]
Pulse frequency	Hz	5 to 15 Hz
Operating temperature range	°C [°F]	5 to 50 [41 to 122]
Weight	g [oz]	73 [2.58]
Material	Main unit	Aluminum alloy
	Bracket	Mild steel (Nickel plated)
Port size		IN: 1/4 NPT
		OUT: 1/4 NPT

Note 1: Air that is used should be clean air that contains no oil or foreign matter, etc. If liquid or dust gets into the pulse blow unit, it may cause defective operation.
 Note 2: This product uses grease internally.

Order Codes

● Main unit

PAU-F11-



Blank: No bracket
 21: With bracket (attached)

● Additional parts (sold separately)

Bracket (2 M3 screws included)

PAUZ-21

Dimensions mm [in]

● Main unit PAU-F11

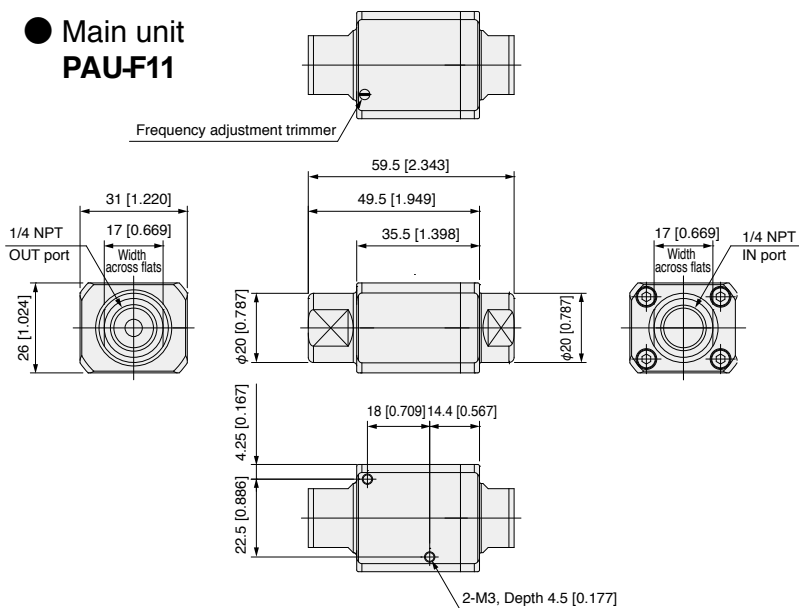

Additional parts (sold separately)

● Bracket PAUZ-21

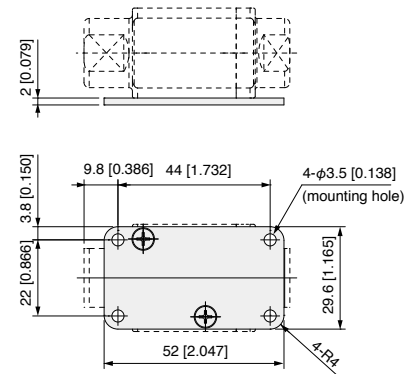

Frequency adjustment method

The pulse frequency can be adjusted by rotating the frequency adjustment trimmer, as shown in the figure at right.

Use a small flat blade screwdriver for adjustments.

Toward + (counterclockwise): Increases frequency.

Toward - (clockwise) : Decreases frequency.

Note: Turning the trimmer counterclockwise raises the frequency and turning it clockwise lowers the frequency. However, turning the trimmer further than needed, after fully opening or closing it, may damage component parts.

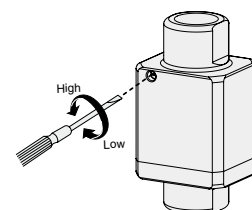

Characteristics of the frequency and flow according to the number of rotations of the trimmer

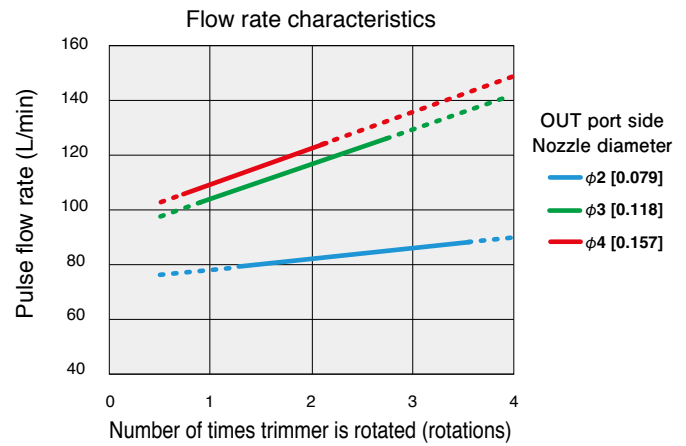
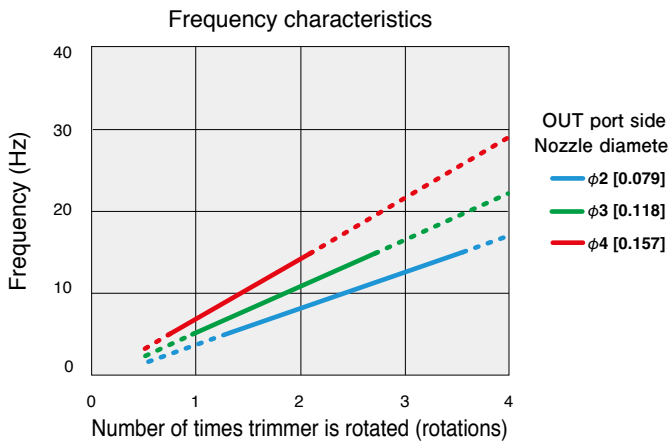

Note 1: According to Koganei testing conditions ①.

Note 2: The characteristics of the frequency and the flow vary depending on the usage and piping conditions.

Note 3: Use devices within the pulse frequency ranges (5 to 15 Hz) shown in the specification charts.

Testing conditions ①

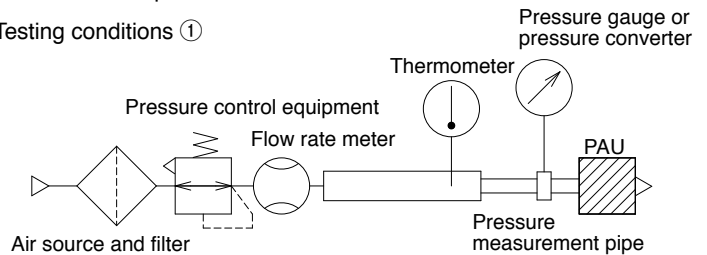

Operations according to piping conditions for pulse blow units

The piping conditions on the IN port side may cause operations to become unstable. See the following table.

Nozzle diameter	Operating pressure	φ 6 [0.236] tube			φ 8 [0.315] tube		
		1000 mm [39.370 in]	3000 mm [118.110 in]	5000 mm [196.850 in]	1000 mm [39.370 in]	3000 mm [118.110 in]	5000 mm [196.850 in]
φ 2 [0.079]	0.35 MPa [51 psi]	○	○	○	○	○	○
	0.5 MPa [73 psi]	○	○	○	○	○	○
	0.7 MPa [102 psi]	○	○	○	○	○	○
φ 3 [0.118]	0.35 MPa [51 psi]	○	○	×	○	○	○
	0.5 MPa [73 psi]	○	○	○	○	○	○
	0.7 MPa [102 psi]	○	○	○	○	○	○
φ 4 [0.157]	0.35 MPa [51 psi]	○	×	×	○	○	○
	0.5 MPa [73 psi]	○	×	×	○	○	○
	0.7 MPa [102 psi]	○	×	×	○	○	○

Note 1: ○ indicates stable operations and × indicates unstable operations (according to Koganei testing conditions ②)

Note 2: Operations will be unstable if the piping conditions cause pressure drops or insufficient flow.

Testing conditions ②

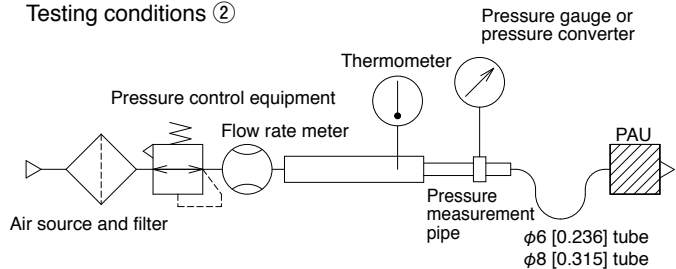

Handling precautions

WARNING

- Use safety glasses and earplugs because blowing air could blow objects into people's eyes or cause hearing loss.
- Install a cutoff valve on the IN port side to ensure safety in case of leaks or damage.

CAUTION

- Air containing oil or solids cannot be used. Use cleaned air for the medium (filtered to 40 μm or finer). If liquid or dust gets into the product, it may cause defective operation.
- Pass the medium through a device, such as a freeze-type air dryer or after cooler, to lower the dew-point temperature of the medium to below the ambient temperature so condensation or frost does not occur when the products are blowing.

- Use the product within the pulse frequency ranges shown in the specification charts.
- This product operates on a balance of pressure, so supply enough pressure and volume to keep the pulse operation steady.
- We recommend the products and air blow guns be connected 1 to 1.
- If you install the product in a location separated from the air blow gun, we recommend using a φ8×6 [0.315×0.236] tube less than 2 m [6.562 ft] long to connect them.
- Use a wrench to hold down the flat part of the product, and then tighten within the following torque range when piping the IN port and OUT port.
Recommended tightening torque:
7 to 9 N·m [5.163 to 6.638 ft·lb]
- Use tubing with an exterior that is not damaged. Do not allow tubing to become severely bent or twisted near the IN port. Doing so could cause air leakage.

CAUTION *Read the safety precautions on the general catalog homepage before using this product.

Pulse blow unit

PAU-30-F11 series Large flow volume type



Specifications

Item	Model	
	PAU-30-F11-02 (-25)	PAU-30-F11-03 (-25)
Medium	Air	
Operating pressure range MPa [psi]	0.35 to 0.7 [51 to 102]	
Pulse frequency Hz	5 to 15	
Operating temperature range °C [°F]	5 to 50 [41 to 122]	
Weight g [oz]	105(113) [3.70(3.99)]	100(108) [3.53(3.81)]
Material	Aluminum alloy	
Port size	IN	1/4 NPT
	OUT	3/8 NPT

Note 1: Air that is used should be clean air that contains no oil or foreign matter, etc.
If liquid or dust gets into the pulse blow unit, it may cause defective operation.
Note 2: This product uses grease internally.

Order Codes

● Main unit

PAU-30-F11- -

Blank: No mounting holes or brackets
25: Direct mounting

02: 1/4 NPT (IN and OUT Ports)
03: 3/8 NPT (IN and OUT Ports)

Dimensions mm [in]

● Main unit

PAU-30-F11-

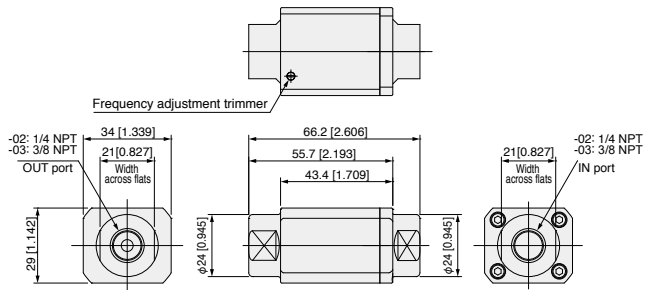

PAU-30-F11- - 25

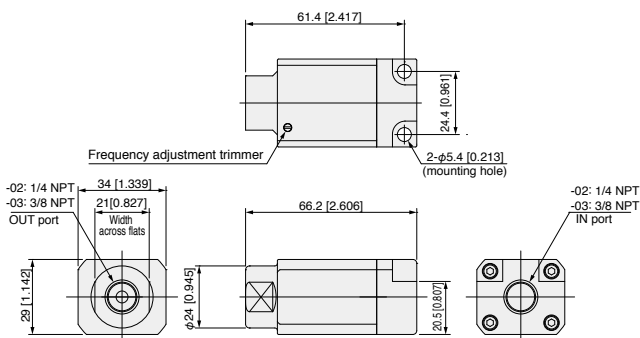

Characteristics of the frequency and flow according to the number of rotations of the trimmer

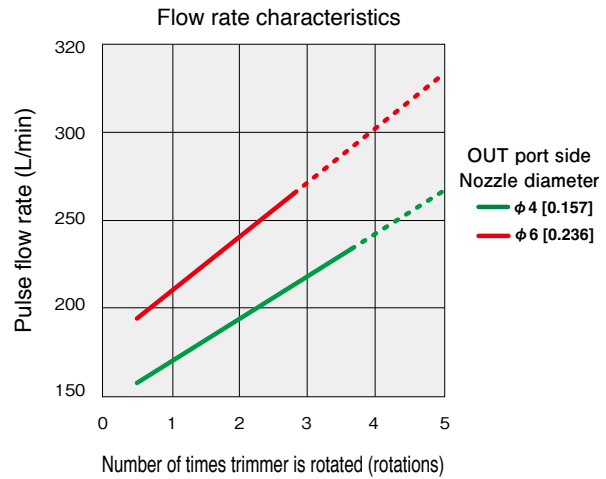
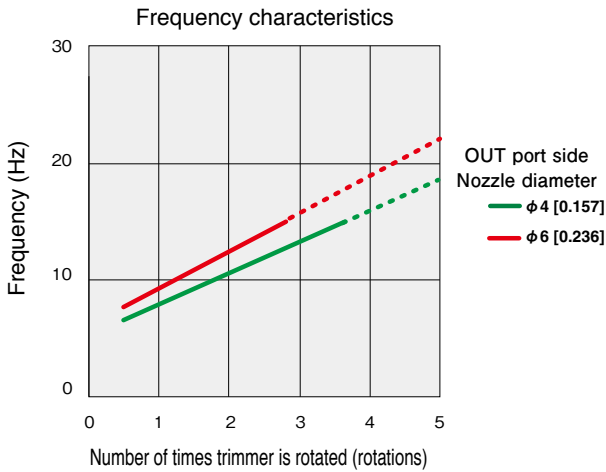

Note 1: According to Koganei testing conditions ①.

Note 2: The characteristics of the frequency and the flow vary depending on the usage and piping conditions.

Note 3: Use devices within the pulse frequency ranges (5 to 15 Hz) shown in the specification charts.

Testing conditions ①

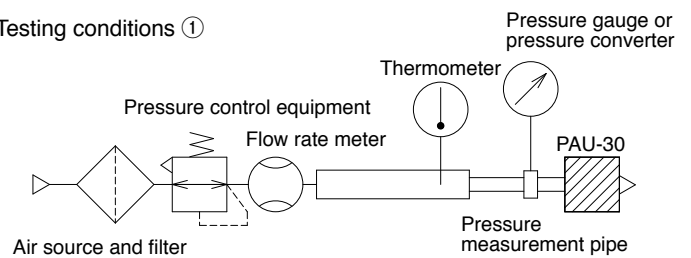

Operations according to piping conditions for pulse blow units

The piping conditions on the IN port side may cause operations to become unstable. See the following table.

Nozzle diameter	Operating pressure	φ 8 [0.315] tube		φ 10 [0.394] tube		φ 12 [0.472] tube	
		1000 mm [39.370 in]	5000 mm [196.850 in]	1000 mm [39.370 in]	5000 mm [196.850 in]	1000 mm [39.370 in]	5000 mm [196.850 in]
φ 4 [0.157]	0.35 MPa [51 psi]	○	△	○	○	○	○
	0.5 MPa [73 psi]	○	△	○	○	○	○
	0.7 MPa [102 psi]	○	△	○	○	○	○
φ 6 [0.236]	0.35 MPa [51 psi]	○	△	○	△	○	○
	0.5 MPa [73 psi]	○	△	○	△	○	○
	0.7 MPa [102 psi]	○	△	○	△	○	○

Testing conditions ②

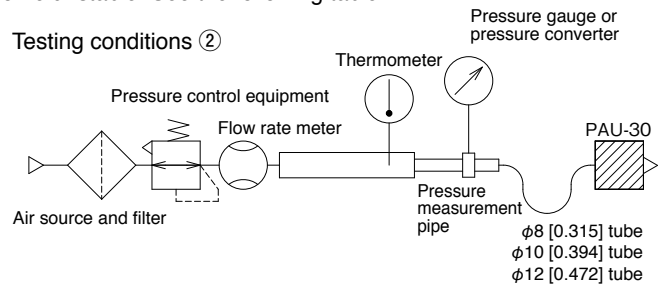

Note 1: ○ indicates stable operations and △ indicates a minimum frequency of 5 to 10 Hz (according to Koganei testing conditions ②)

Note 2: Operations will be unstable if the piping conditions cause pressure drops or insufficient flow.

Handling precautions

⚠ WARNING

- Use safety glasses and earplugs because blowing air could blow objects into people's eyes or cause hearing loss.
- Install a cutoff valve on the IN port side to ensure safety in case of leaks or damage.

⚠ CAUTION

- Air containing oil or solids cannot be used. Use cleaned air for the medium (filtered to 40 μm or finer). If liquid or dust gets into the product, it may cause defective operation.
- Pass the medium through a device, such as a freeze-type air dryer or after cooler, to lower the dew-point temperature of the medium to below the ambient temperature so condensation or frost does not occur when the products are blowing.

- Use the product within the pulse frequency ranges shown in the specification charts.
- This product operates on a balance of pressure, so supply enough pressure and volume to keep the pulse operation steady.
- We recommend the products and air blow guns be connected 1 to 1.
- If you install the product in a location separated from the air blow gun, we recommend using a φ8×6 [0.315×0.236] tube less than 2 m [6.562 ft] long to connect them.
- Tighten within the following torque range when piping the IN port and OUT port.

Recommended tightening torque	PAU-30-02 (-25)	PAU-30-03 (-25)
	N·m [ft·lbf]	7 to 9 [5.163 to 6.638]

* Piping for both IN port side and OUT port side

- Use tubing with an exterior that is not damaged. Do not allow tubing to become severely bent or twisted near the IN port. Doing so could cause air leakage.

⚠ CAUTION *Read the safety precautions on the general catalog homepage before using this product.

Limited Warranty

KOGANEI CORP. warrants its products to be free from defects in material and workmanship subject to the following provisions.

Warranty Period The warranty period is 180 days from the date of delivery.

Koganei Responsibility If a defect in material or workmanship is found during the warranty period, KOGANEI CORP. will replace any part proved defective under normal use free of charge and will provide the service necessary to replace such a part.

Limitations

- This warranty is in lieu of all other warranties, expressed or implied, and is limited to the original cost of the product and shall not include any transportation fee, the cost of installation or any liability for direct, indirect or consequential damage or delay resulting from the defects.

- KOGANEI CORP. shall in no way be liable or responsible for injuries or damage to persons or property arising out of the use or operation of the manufacturer's product.

- This warranty shall be void if the engineered safety devices are removed, made inoperative or not periodically checked for proper functioning.

- Any operation beyond the rated capacity, any improper use or application, or any improper installation of the product, or any substitution upon it with parts not furnished or approved by KOGANEI CORP., shall void this warranty.

- This warranty covers only such items supplied by KOGANEI CORP. The products of other manufacturers are covered only by such warranties made by those original manufacturers, even though such items may have been included as the components.

The specifications are subject to change without notice.



International America, Inc.

48860 Milmont Drive Suite 108C
Fremont, CA 94538

TEL: 1-855-KOGANEI (564 2634)

FAX: 510-744-1676

MAIL: sales@koganeiusa.com

Web: www.koganeiusa.com