

ACCESSORIES

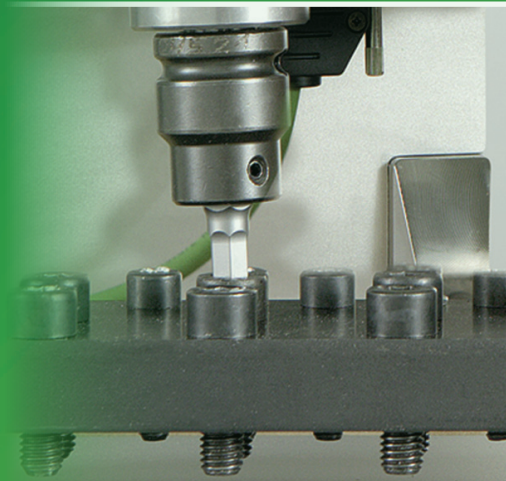

Inserting Tools for Screwdrivers

- Bits
- Sockets
- Finders
- Bit holders



With the longest lifetime and highest wear resistance combined with the best fits, our inserting tools are designed for the industrial use.

The large variety of this assortment combines standard inserts and inserts for special applications. If those cannot be used, With the longest lifetime and highest wear resistance combined with the best fits, our inserting tools are designed for the industrial use.

The large variety of this assortment combines standard inserts and inserts for special applications. If those cannot be used, we also offer custom made bits. Whatever fastener needs to be assembled, we have the right tool for you. To achieve the utmost economical solution in regard to wear, usage and price, DEPRAG will support you with detailed advise and service. Please don't hesitate to ask us.

PRODUCT SPECTRUM INSERTING TOOLS

Inserting Tools

Type of Screw

find on

for NANOMAT and MICROMAT Screwdrivers

bits, finders	slotted screws	Page 3
bits, finders, bit holders	PHILLIPS and POZIDRIV screws	Page 4
bits, bit holders	allen screws, torx screws and threaded pins	Page 4/5
sockets with shaft	hex. screws and hex. nuts	Page 5
semi-finished bits and finders, special bits	–	Page 5

for MINIMAT, Recycling, Slip clutch, Pulse tools, Electric Screwdrivers

bits, finders, bit holders, special bits	slotted screws	Page 6/7
bits, finders, bit holders	PHILLIPS and POZIDRIV screws	Page 8/9
threaded bit tips, bit holder (threaded), semi-finished finders, special bits, adapters and chuck for stud screws		Page 10/11
threaded bit tips	torx screws	Page 10
bits, bit holders	allen screws, torx screws and threaded pins	Page 12/13

for SENSOMAT and MINIMAT-T Screwdrivers

sensor sleeves, bits	slotted screws	Page 14/15
sensor sleeves, bits, bit holders	PHILLIPS and POZIDRIV screws	Page 14/15

for Ratchet wrench

sockets, holder	hex. screws and hex. nuts	Page 16
-----------------	---------------------------	---------

for MINIMAT, Recycling, Slip clutch, Pulse tools, Electric Screwdriver, Impact Wrenches and EC-SERVO Screwdriver

sockets	hex. screws and hex. nuts	Page 16/17/18
extensions / ball joints	internal-□, external-□	Page 18/19
bits, holder	internal hex. screws, threaded pins	Page 19/20
chuck for stud screws	stud screws	Page 19
locking pins and rubber rings	–	Page 20

FIND A MUCH LARGER RANGE OF INSERTING TOOLS ON THE INTERNET

Inserting Tools for Screwdrivers

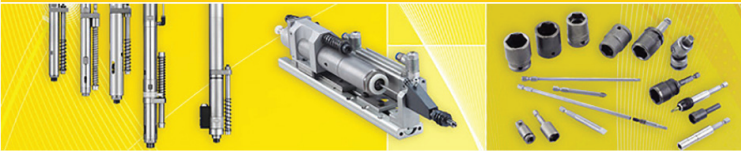

Your Online Selection Tool

One stop shop
 Process reliable
 Efficient
 Economical
 High degree of reusability

shape of bit tip:

size of bit tip:

drive:

length of bit:

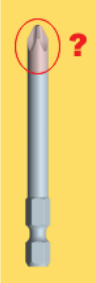

This brochure shows a small selection of inserting tools available for our NANOMAT/MICROMAT/MINIMAT screwdrivers.

You will find a much larger range of these inserting tools on our website:

Online Selection Tool

This selection program is updated permanently and allows you to look for suitable inserting tools for your DEPRAG screwdriver yourself.

Simply pick the required parameters from the shown listing by mouse click and you will get the respective part no. including an information about the lead time.

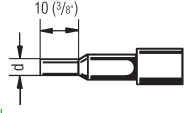
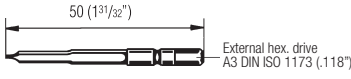

All you have to do now is to send an inquiry to export@deprag.de via e-mail and we will arrange to send you our related offer either directly or via our respective local representative.

Bits, finders (without and with screw suction)

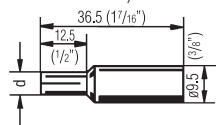

slotted screws		finder 1) *)			bit		
							
head dia.		d		Part no.	blade		Part no.
mm	in.	mm	in.		mm	in.	
3.0	.118	4.0	.16	325612	0.4 x 2.0	.016 x .080	341689
3.0	.118	4.0	.16	341697	0.4 x 2.5	.016 x .098	341690
3.8	.150	4.8	.19	323862	0.5 x 3.0	.020 x .122	323854
4.2	.165	5.3	.21	341739	0.6 x 3.5	.024 x .134	341691
4.3	.170	5.5	.22	341740	0.5 x 3.0	.020 x .122	323854
4.5	.177	5.6	.22	341698	0.6 x 3.5	.024 x .134	341691
4.7	.185	5.8	.23	341702	0.6 x 3.5	.024 x .134	
5.6	.220	6.6	.26	323864	0.8 x 4.0	.032 x .154	341692

1) hereto spring sleeve cpl., see leaflet of respective screwdriver accessories (optional equipment)

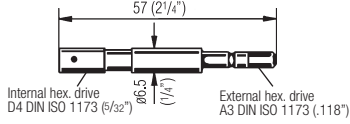
Bits, slotted finders, bit holder (non-magnetic)

slotted screws		finder *)			bit			bit holder (non-magnetic)	
									
head dia.		d		Part no.	blade		Part no.		
mm	in.	mm	in.		mm	in.			
3.8	.150	5.0	.20	803940	0.5 x 3	.020 x .122	803606		
4.2	.165	5.5	.22	341783	0.6 x 3.5	.024 x .134	803935		
4.3	.170	5.5	.22	—	0.5 x 3	.020 x .122	803606		
4.5	.177	6.0	.24	—	0.6 x 3.5	.024 x .134	803935		
4.7	.185	6.0	.24	—	0.6 x 3.5	.024 x .134	803935		
5.5	.216	7.0	.28	803943	0.8 x 4	.032 x .154	803607		
5.6	.220	7.0	.28		0.8 x 4	.032 x .154	803607		

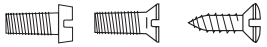
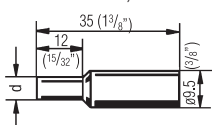

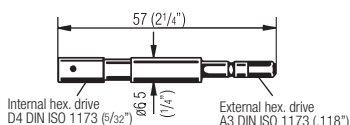
Bits, finders, bit holder (magnetic)

slotted screws		finder *)			bit			bit holder (non-magnetic)	
									
head dia.		d		Part no.	blade		Part no.		
mm	in.	mm	in.		mm	in.			
3.8	.150	5.0	.20	803945	0.5 x 3	.020 x .122	803606		
4.2	.165	5.5	.22	803949	0.6 x 3.5	.024 x .134	803935		
4.3	.170	5.5	.22		0.6 x 3.5	.024 x .134	803935		
4.5	.177	5.5	.22	803946	0.6 x 3.5	.024 x .134	803929		
4.7	.185	6.0	.24	803946	0.6 x 3.5	.024 x .134	803929		
5.5	.216	7.0	.28	803948	0.8 x 4	.032 x .154	803607		
5.6	.220	7.0	.28		0.8 x 4	.032 x .154	803607		

*) suitable for MICROMAT screwdrivers. Finders for NANOMAT on special request.

FOR NANOMAT and MICROMAT SCREWDRIVER



Bits, finders (without and with screw suction)

 PHILLIPS screws  POZIDRIV screws			without screw suction bit		finder 1) *)			with screw suction bit	
point size	head dia.		PHILLIPS Part no.	POZIDRIV Part no.	mm	in.	Part no.	PHILLIPS Part no.	POZIDRIV Part no.
	mm	in.							
0	3.0	.118	323906	803613	3.8	.15	323861	323906	353571
0	3.2	.125			4.2	.16	329719		
1	3.8	.150			4.8	.19	323862		
1	4.0	.157			5.2	.20	326230		
1	4.2	.165			5.2	.20	324571		
1	4.3	.170			5.7	.22	324341		
1	4.7	.185			6.6	.26	326231		
1	5.0	.196			6.6	.26	323864		
1	5.5	.216			7.0	.27	324659		
1	5.6	.220							
1	6.0	.236							



1) hereto spring sleeve cpl., see leaflet of respective screwdriver accessories (optional equipment)

*) suitable for MICROMAT screwdriver. Finders for NANOMAT on special request.

Bits, bit holders (non-magnetic and magnetic)

 PHILLIPS screws  POZIDRIV screws			bit		bit holder (non-magnetic) or bit holder (magnetic)	
point size	PHILLIPS Part no.	POZIDRIV Part no.	Part no.	Part no.	Part no.	Part no.
1	803951	803925				
2	803952	803612				



Bits, bit holders (non-magnetic and magnetic)

 allen screws, threaded pins  Torx screws		allen bit		Torx bit		bit holder (non-magnetic) or bit holder (magnetic)	
AF mm	Torx size	Part no.	Part no.	Part no.	Part no.	Part no.	Part no.
1.5	—	803956	803600				
1.5	T 6	—	803604				
—	T 7	—	803601				
2	T 8	803957	803603	803930	803929		
—	T 9	—					
2	T 10	803957	803602				
2.5	T 10	803958					
3	T 15	803959	803608				

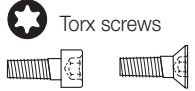
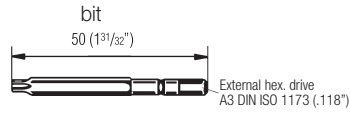
Bits

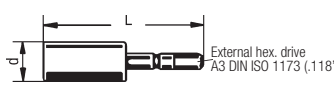

 <p>Torx screws</p>	 <p>bit 50 (1³¹/₃₂" External hex. drive A3 DIN ISO 1173 (.118")</p>	
	Torx size	Part no.
	T 6	803926
	T 7	803586
	T 8	803587
T 10	803589	

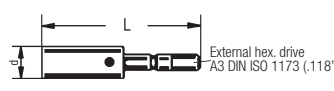
Sockets with shaft (without and with screw suction)

 <p>hex. screws hex. nuts</p>	<p>without screw suction</p> <p>socket with shaft</p>  <p>External hex. drive A3 DIN ISO 1173 (.118")</p>				<p>with screw suction</p> <p>spring sleeve *)</p> 				<p>socket with shaft</p>  <p>External hex. drive A3 DIN ISO 1173 (.118")</p>				
	AF mm	AF in.	d mm	L in.	Part no.	Part no.	d mm	L in.	Part no.				
			mm	in.	mm	in.			mm	in.	mm	in.	Part no.
	4.0	5/32	8	5/16	43	1 ¹¹ / ₁₆	803960	330633	7	9/32	40	1 ⁹ / ₁₆	324587
	5.0	—	9	23/64	43	1 ¹¹ / ₁₆	803961	330634	8	5/16	40	1 ⁹ / ₁₆	324588
5.5	7/32	10	23/64	43	1 ¹¹ / ₁₆	803962		8	5/16	44	1 ²³ / ₃₂	324589	

Semi-finished bits and finders (not hardened)

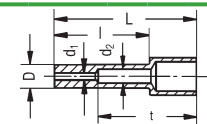
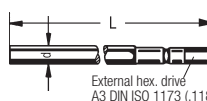
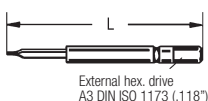
special bits

<p>finder *)</p> 													 <p>External hex. drive A3 DIN ISO 1173 (.118")</p>				 <p>External hex. drive A3 DIN ISO 1173 (.118")</p>				 <p>External hex. drive A3 DIN ISO 1173 (.118")</p>						
D mm	D in.	d ₁ mm	d ₁ in.	d ₂ mm	d ₂ in.	L mm	L in.	l mm	l in.	t mm	t in.	Part no.	d mm	L mm	L in.	Part no.	blade mm	blade in.	L mm	L in.	Part no.	point size	mm	in.	PHILLIPS Part no.	POZIDRIV Part no.	
5.0	.20	1.5	.06	3.0	.12	30.5	1 ¹³ / ₆₄	24	15/16	19.5	49/64	490013V	3.6	.14	102	4	490230V	0.20x1.0	.008x.040	50	1 ³¹ / ₃₂	324098	1	75	2 ¹⁵ / ₁₆	328176	333917
5.5	.22	1.5	.06	3.9	.15	30.5	1 ¹³ / ₆₄	24	15/16	19.5	49/64	490014V	3.6	.14	130	5 ¹ / ₈	490229V	0.25x1.5	.010x.060	50	1 ³¹ / ₃₂	324099	1	90	3 ⁹ / ₁₆	339921	339922
6.6	.26	1.5	.06	4.8	.19	31.5	1 ¹ / ₄	25	31/32	20.5	13/16	490015V	4.0	.16	100	3 ¹⁵ / ₁₆	490228V	0.25x2.0	.010x.080	50	1 ³¹ / ₃₂	324100	1	102	4	327520	337990
6.6	.26	—	—	4.8	.19	84.5	3 ² / ₆₄	78	3 ¹ / ₁₆	20.5	13/16	490069V	4.0	.16	152	6	490212V	0.40x4.0	.016x.154	90	3 ⁹ / ₁₆	339923	0	152	6	348426	—
																		0.50x4.0	.020x.154	90	3 ⁹ / ₁₆	339924	1	152	6	348430	348431
																		0.70x4.0	.028x.154	90	3 ⁹ / ₁₆	339925					

*) suitable for MICROMAT screwdriver. Spring sleeves or finder for NANOMAT on special request.

FOR MINIMAT, RECYCLING, SLIP CLUTCH SCREWDRIVERS

 slotted screws

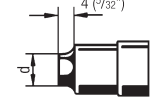
 short execution without screw suction
4 (9/32")

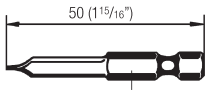
 50 (1¹⁵/₁₆)

External hex. drive
E6.3 DIN ISO 1173 (1/4")

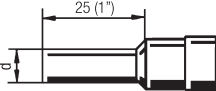
 long execution without screw suction
25 (1")

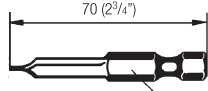
 70 (2³/₄)

External hex. drive
E6.3 DIN ISO 1173 (1/4")

with screw suction (only
MINIMAT straight screwdr.
size 1 and size 2)

head dia.		d		finder 1) Part no.	blade		bit Part no.	d		finder 1) Part no.	blade		bit Part no.
mm	in.	mm	in.		mm	in.		mm	in.		mm	in.	
3.8	.150	5.5	.22		0.5 x 3	.020 x .122		6	.24	325246	0.5 x 3	.020 x .122	804021
4	.157	5.5	.22	322575	0.5 x 3	.020 x .122	804001	—	—	—	—	—	—
4.2	.165	5.5	.22		0.5 x 3	.020 x .122		6	.24	325247	0.5 x 3	.020 x .122	
4.3	.170	6	.24	342338	0.6 x 3.5	.024 x .134		6	.24	325248	0.5 x 3	.020 x .122	804021
4.5	.177	6	.24		0.6 x 3.5	.024 x .134	803598	6	.24	325249	0.5 x 3	.020 x .122	
4.7	.185	7	.28	342337	0.6 x 3.5	.024 x .134		6.5	.26	325249	0.5 x 3	.020 x .122	
5	.196	7	.28	342346	0.6 x 4.5	.024 x .177	803590	—	—	—	—	—	—
5.6	.220	7	.28	322573	0.8 x 4	.032 x .154	803592	7	.28	325133	0.8 x 4	.032 x .154	
6	.236	7.5	.30	342340	0.8 x 5.5	.032 x .215	804012	7.5	.30	325751	0.8 x 4	.032 x .154	803595
6.5	.255	8.5	.33	342344	0.8 x 4	.032 x .154	803592	—	—	—	—	—	—
6.9	.271	8.5	.33		1 x 5.5	.038 x .215	803593	8.5	.33	325250	1 x 5.5	.038 x .215	803596
7	.275	8.5	.33	342339	0.8 x 5.5	.032 x .215	804012	—	—	—	—	—	—
7	.275	8.5	.33		1 x 5.5	.038 x .215	803593	8.5	.33	325250	1 x 5.5	.038 x .215	803596
7.5	.295	9.5	.37	342342	1 x 5.5	.038 x .215		9	.35	342258	1 x 5.5	.038 x .215	
8.2	.323	9.5	.37	342341	1.2 x 6.5	.046 x .255	803872	9.5	.37	342249	1.2 x 6.5	.046 x .255	803873
8.3	.326	10.5	.41	342345	1 x 5.5	.038 x .215	803593	—	—	—	—	—	—
8.5	.334	12	.47	322630	1.2 x 8	.046 x .255	804007	10	.39	342248	1.2 x 6.5	.046 x .255	803873
9	.354	10.5	.41	342345	1 x 5.5	.038 x .215	803593	—	—	—	—	—	—
9.2	.362	12	.47		1.2 x 8	.046 x .312		11	.43	325255	1.2 x 8	.046 x .312	
9.5	.374	12	.47		1.2 x 8	.046 x .312	804007	11	.43	325256	1.2 x 8	.046 x .312	804027
10	.395	12	.47		1.2 x 8	.046 x .312		12	.47	325170	1.2 x 8	.046 x .312	
10	.395	12	.47		1.6 x 8	.063 x .312		12	.47		1.6 x 8	.063 x .312	
11	.433	13	.51	342343	1.6 x 8	.063 x .312	803594	13	.51	342260	1.6 x 8	.063 x .312	803597

FOR MINIMAT, SLIP CLUTCH SCREWDRIVERS

 slotted screws

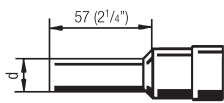
 57 (2¹/₄)

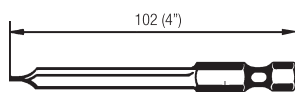
 102 (4")

External hex. drive
E6.3 DIN ISO 1173 (1/4")

Special bits, finders

head dia.		d		finder 1) Part no.	blade		bit Part no.
mm	in.	mm	in.		mm	in.	
3.8	.150	—	—	—	—	—	—
4	.157	—	—	—	—	—	—
4.2	.165	6	.24		0.7 x 3.5	.028 x .134	
4.3	.170	6	.24	353891	0.7 x 3.5	.028 x .134	
4.5	.177	6	.24	353892	0.7 x 3.5	.028 x .134	804013
4.7	.185	6.5	.26	353894	0.7 x 3.5	.028 x .134	
5	.196	—	—	—	—	—	—
5.6	.220	7	.28	353897	0.8 x 4	.032 x .154	804014
6	.236	7.5	.30	333680	0.8 x 4.7	.032 x .187	804018
6.5	.255	—	—	—	—	—	—
6.9	.271	8.5	.33	332770	0.9 x 5.5	.036 x .215	804015
7	.275	—	—	—	—	—	—
7	.275	8.5	.33	332770	0.9 x 5.5	.036 x .215	804015
7.5	.295	9	.35	346365	1 x 6.3	.038 x .250	804019
8.2	.323	9.5	.37	333681	1 x 7	.038 x .275	804016
8.3	.326	—	—	—	—	—	—
8.5	.334	10	.39	351811	1 x 7	.038 x .275	804016
9	.354	—	—	—	—	—	—
9.2	.362	11	.43	331735	1.2 x 8	.046 x .312	
9.5	.374	11.5	.45	351813	1.2 x 8	.046 x .312	
10	.395	12	.47		1.2 x 8	.046 x .312	
10	.395	12	.47	326388	1.2 x 8	.046 x .312	804017
11	.433	13	.51	326389	1.2 x 8	.046 x .312	

¹⁾ hereto spring sleeve cpl., see leaflet of respective screwdriver accessories (optional equipment)

Bits, finders, bit holders (non-magnetic and magnetic)

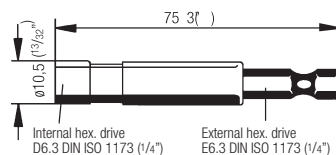
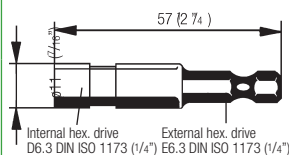
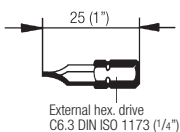
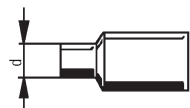

d		finder Part no.	blade		bit Part no.	bit holder (non-magnetic) Part no.	bit holder (magnetic) Part no.
mm	in.		mm	in.			
6	.24	354698	0.5 x 3	.020 x .122	820883	804602	821068
6	.24		0.5 x 3	.020 x .122			
6.5	.26	354699	0.6 x 3.5	.024 x .134	8210713		
6.5	.26		0.6 x 3.5	.024 x .134			
7	.28	354700	0.6 x 3.5	.024 x .134	8210713		
7	.28		0.6 x 3.5	.024 x .134			
7.5	.30	341388	0.6 x 4.5	.024 x .177	803841		
8	.31	354701	0.8 x 5	.032 x .196	803842		
8	.31	334920	0.8 x 5.5	.032 x .215	803969		
8.5	.33	354702	0.8 x 5.5	.032 x .215			
9	.35	354468	0.8 x 5.5	.032 x .215	8210723		
9	.35		0.8 x 5.5	.032 x .215			
9	.35	354703	1.2 x 6.5	.046 x .255	821075		
10	.39	354704	1 x 5.5	.038 x .215	821075		
10.5	.41	354705	1.2 x 6.5	.046 x .255	8210723		
10.5	.41	354706	1 x 5.5	.038 x .215	821075		
10.5	.41	354707	1.2 x 8	.046 x .312	803846		
11	.43	354708	1 x 5.5	.038 x .215	821075		
11.5	.45	354709	1.2 x 6.5	.046 x .255	8210723		
11.5	.45	354710	1.2 x 8	.046 x .312	803846		
12.5	.49	354711	1.2 x 8	.046 x .312			
12.5	.49	354712	1.6 x 8	.063 x .312	821076		
13.5	.53		1.6 x 8	.063 x .312			

without screw suction / with screw suction (only MINIMAT straight screwdriver size 1 and size 2)

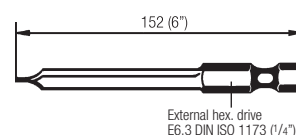
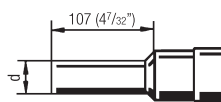
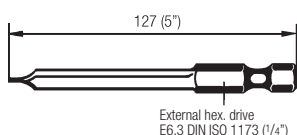
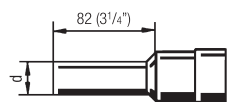

d		finder 1) Part no.	blade		bit Part no.	d		finder 1) Part no.	blade		bit Part no.
mm	in.		mm	in.		mm	in.		mm	in.	
—	—	—	—	—	—	—	—	—	—	—	—
—	—										
—	—										
—	—										
—	—										
—	—										
7	.28	353904	0.8 x 4	.032 x .154	804034	7	.28	343915	0.8 x 4	.032 x .154	803979
7.5	.30	330731	0.8 x 4.7	.032 x .187	804039	7.5	.30	328972	0.8 x 4.7	.032 x .187	803980
—	—	353905	—	—	804035	—	—	353911	—	—	803981
8.5	.33		0.9 x 5.5	.036 x .215		8.5	.33		0.9 x 5.5	.036 x .215	
8.5	.33	353905	0.9 x 5.5	.036 x .215	804035	8.5	.33	353911	0.9 x 5.5	.036 x .215	803981
9	.35	330178	1 x 6.3	.038 x .250	804033	9	.35	—	1 x 6.3	.038 x .250	803982
9.5	.37	353906	1 x 7	.038 x .275	804036	9.5	.37	353913	1 x 7	.038 x .275	803983
—	—	326669	—	—	804036	—	—	332775	—	—	803983
10	.39		1 x 7	.038 x .275		10	.39		1 x 7	.038 x .275	
—	—	353907	—	—	8040371	—	—	—	—	—	803984
11	.43		1.2 x 8	.046 x .312		11	.43		1.2 x 8	.046 x .312	
11.5	.45	353909	1.2 x 8	.046 x .312	8040371	11.5	.45	—	1.2 x 8	.046 x .312	803984
12	.47	325518	1.2 x 8	.046 x .312		12	.47	337006	1.2 x 8	.046 x .312	
12	.47		1.2 x 8	.046 x .312		12	.47		1.2 x 8	.046 x .312	
13	.51	—	1.2 x 8	.046 x .312		13	.51	—	1.2 x 8	.046 x .312	

1) hereto spring sleeve cpl., see leaflet of respective screwdriver accessories (optional equipment)

FOR MINIMAT, RECYCLING, SLIP CLUTCH, PULSE TOOLS, ELECTRIC SCREWDRIVERS

 PHILLIPS screws

 POZIDRIV screws

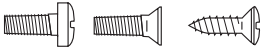

Bits

short execution
without screw suction

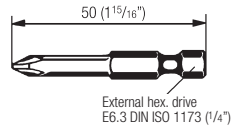

long execution
without screw suction

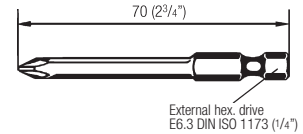

point size	head dia.		PHILLIPS Part no.	POZIDRIV Part no.	PHILLIPS Part no.	POZIDRIV Part no.
	mm	in.				
0	3.8	.150	804040	—	804045	—
1	3.8	.150	804041	803985	804046	803988
1	4	.157				
1	4.3	.170				
1	4.7	.185				
1	5	.196				
1	5.6	.220				
1	6	.236				
2	6.5	.255				
2	6.9	.271				
2	7	.275				
2	7.5	.295				
2	8.2	.323				
2	8.3	.326				
2	9	.354				
2	9.2	.362				
2	9.5	.374				
2	10	.395				
3	11	.433				
3	12	.472				
3	12.5	.492				
4	14.5	.573				
4	16	.630				
			804044	803991	—	—

FOR MINIMAT, RECYCLING, SLIP CLUTCH, ELECTRIC SCREWDRIVERS

 PHILLIPS screws

 POZIDRIV screws



without
screw suction

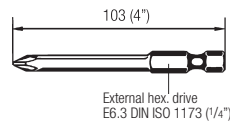

with screw suction (only
MINIMAT straight screwdriver size 1 and size 2)

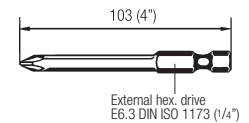
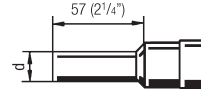

point size	head dia.		PHILLIPS Part no.	POZIDRIV Part no.	d		finder 1) Part no.	PHILLIPS Part no.	POZIDRIV Part no.
	mm	in.			mm	in.			
1	3.8	.150	324963	324686	7	.28	—	353921	353922
1	4	.157			7	.28	353931		
1	4.3	.170			7	.28	353933		
1	4.7	.185			7	.28	353934		
1	5	.196			7	.28	353935		
1	5.6	.220			7.5	.30	334181		
1	6	.236			7.5	.30	333680		
2	6.5	.255			—	—	—		
2	6.9	.271			8.5	.33	338337		
2	7	.275			—	—	—		
2	7.5	.295	9	.35	346365				
2	8.2	.323	10	.39	344104				
2	8.3	.326	—	—	—				
2	9	.354	—	—	—				
2	9.2	.362	—	—	—				
2	9.5	.374	—	—	—				
2	10	.395	—	—	—				
			324331	324842	11	.43	331735	324331	324842
					11.5	.45	351813		
					12	.47	326388		

¹⁾ hereto spring sleeve cpl., see leaflet of respective screwdriver accessories (optional equipment)

Bits, finders

long execution, with screw suction (only MINIMAT straight screwdriver size 1 and size 2)

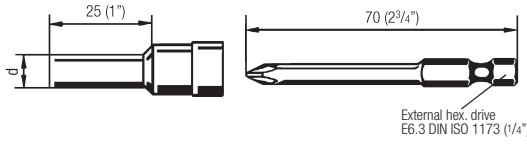

Bits, bit holders (non-magnetic and magnetic)

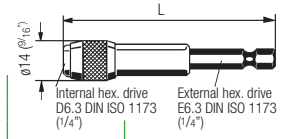
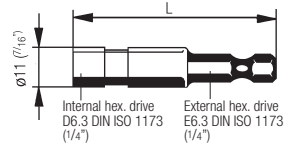
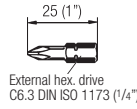

mm	d in.	finder 1) Part no.	PHILLIPS Part no.	POZIDRIV Part no.	PHILLIPS Part no.	POZIDRIV Part no.	non-magnetic		magnetic		magnetic and quick change chuck				
							mm	L in.	mm	L in.	mm	L in.	Part no.		
6	.24	325246	804045	—	804635	8046413									
6	.24	—	—	—	—	—									
5	.20	330742	338894	339140											
6	.24	325247			804636	804665									
6.5	.26	325249													
6.5	.26	329280													
7	.28	325220	804046	803988											
7.5	.30	325181													
—	—	—	—	—					75	3	821068				
8.5	.33	325251	804047	803989			57	2 ¹ / ₄	804602	100	3 ¹⁵ / ₁₆	337722			
—	—	—	—	—			102	4	8046391	150	5 ²⁹ / ₃₂	330744	51.5	2 ¹ / ₃₂	821692
9	.35	325260	804047	803989			152	6	8046141	204	8 ¹ / ₃₂	335481	76.5	3	820150
9.5	.37	325253			804637	804666	203	8	8129441	250	9 ²⁷ / ₃₂	334086	151.5	5 ³¹ / ₃₂	358131
—	—	—	—	—						300	11 ¹³ / ₁₆	330745			
11	.43	325255													
11	.43	325256	804047	803989											
12	.47	325170													
13	.51	342260	804048	803990											
—	—	—	—	—	804638	804667									
—	—	—	—	—	804640	804674									

without screw suction

with screw suction (only MINIMAT straight screwdriver size 1 and size 2)

without screw suction

with screw suction (only MINIMAT straight screwdriver size 1 and size 2)

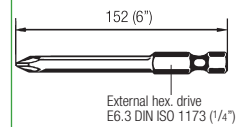
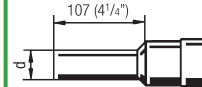
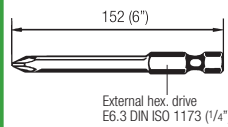
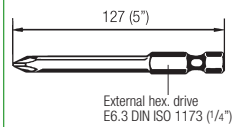
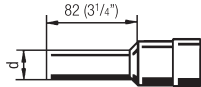
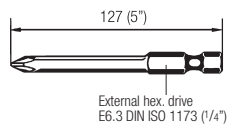

PHILLIPS Part no.	POZIDRIV Part no.	d mm	d in.	finder 1) Part no.	PHILLIPS Part no.	POZIDRIV Part no.	PHILLIPS Part no.	POZIDRIV Part no.	d mm	d in.	finder 1) Part no.	PHILLIPS Part no.	POZIDRIV Part no.
		7	.28	353946					7	.28	353958		
		7	.28	353947	353944	339867			7	.28	—	346327	340727
		7	.28	—			327986	327386	7	.28	—		
		7	.28	353949					7	.28	353961		
		7.5	.30	—					7.5	.30	—	327986	327386
		7.5	.30	330731	325567	330255			7.5	.30	328972		
		—	—	—	—	—			—	—	—	—	—
		9.5	.37	333555	331002	331003			9	.35	332621	328551	330026
		—	—	—	—	—			—	—	—	—	—
		9	.35	330178					9	.35	—		
331002	331003	9.5	.37	353950	331002	331003			9.5	.37	353962	328551	330026
		—	—	—	—	—	328551	330026	—	—	—	—	—
		—	—	—	—	—			—	—	—	—	—
		11	.43	—					11	.43	—		
		11.5	.45	—	331002	331003			11.5	.45	—	328551	330026
		11.5	.45	339264					12	.47	—		

Threaded bit tips

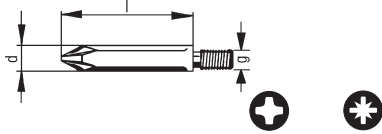

point size	mm	d in.	g	mm	l in.	PHILLIPS Part no.	POZIDRIV Part no.
1	6.35	1/4	10-32	34	1 11/32	8037471	8037481
1	5	13/64	M 4	25	1	8037281	—
1	5.5	7/32	M 4	25	1	—	8037503
2	5.56	7/32	8-32	22	7/8	8037451	8289491
2	6.35	1/4	10-32	34	1 11/32	8037461	8037491
2	6	15/64	M 5	34	1 11/32	803855	803856

Bit holder (threaded)

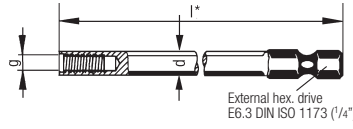

mm	d in.	g	mm	l in.	Part no.
5.6	7/32	8-32	105	4 1/8	337499
5.6	7/32	8-32	130	5 1/8	334316
5.6	7/32	8-32	156	6 5/32	353697
5.6	7/32	8-32	168	6 5/8	334420
5.6	7/32	8-32	178	7	353694
6.35	1/4	10-32	68	2 11/16	337497
6.35	1/4	10-32	93	3 21/32	336707
6.35	1/4	10-32	118	4 21/32	334315
6.35	1/4	10-32	144	5 43/64	341042
6.35	1/4	10-32	156	6 5/32	334421
6.35	1/4	10-32	166	6 17/32	355758
5.5	7/32	M 4	77	3 1/32	337520
5.5	7/32	M 4	102	4 1/64	337521
5.5	7/32	M 4	127	5	335637
5.5	7/32	M 4	153	6 1/32	354233
5.5	7/32	M 4	165	6 1/2	341765
5.5	7/32	M 4	175	6 57/64	347107
7	9/32	M 5	68	2 11/16	348745
7	9/32	M 5	77	3 1/32	344689
7	9/32	M 5	92	3 5/8	349569
7	9/32	M 5	102	4 1/64	344819
7	9/32	M 5	117	4 39/64	345466
7	9/32	M 5	127	5	343309
7	9/32	M 5	143	5 5/8	357736
7	9/32	M 5	155	6 3/32	346886
7	9/32	M 5	165	6 1/2	348235
7	9/32	M 5	170	6 11/16	348417
8	5/16	M 6	77	3 1/32	362258
8	5/16	M 6	102	4 1/64	370770
8	5/16	M 6	127	5	371868
8	5/16	M 6	155	6 3/32	351713
8	5/16	M 6	185	7 9/32	351533

Semi-finished finders (not hardened)

(not for Electric Screwdrivers)

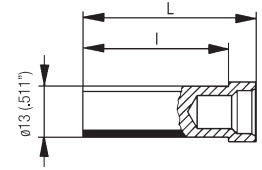

mm	L in.	mm	l in.	bit length		Part no.
				mm	in.	
23	2 9/32	15	1 9/32	50	1 15/16	490199
44	1 23/32	37	1 15/32	70	2 3/4	490031V
64	1 1/2	57	2 1/4	89	3 1/2	490105V
101	3 21/32	94	3 11/16	102/127	4 / 5	490107V
126	3 21/32	119	4 11/16	152	6	490108V

Threaded bit tips

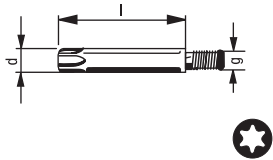

torx size	mm	d in.	g	mm	l in.	torx Part no.
T 10	6	15/64	10-32	34	1 11/32	8222353
T 10	5.5	7/32	M 4	25	1	803753
T 10	6	15/64	M 5	34	1 11/32	8238943
T 15	6	15/64	10-32	34	1 11/32	8129453
T 15	5.5	7/32	M 4	25	1	803754
T 15	6	15/64	M 5	34	1 11/32	8206033
T 20	6	15/64	10-32	34	1 11/32	8202973
T 20	5.5	7/32	M 4	25	1	8037563
T 20	6	15/64	M 5	34	1 11/32	8128943
T 20	7	9/32	M 5	25	1	8210423
T 25	6	15/64	10-32	34	1 11/32	8202983
T 25	5.5	7/32	M 4	25	1	8250083
T 25	6	15/64	M 5	34	1 11/32	8221063
T 25	7	9/32	M 6	25	1	8217603
T 30	6	15/64	10-32	34	1 11/32	8202993
T 30	7	9/32	M 5	25	1	8037063
T 30	7	9/32	M 6	25	1	8210613
T 40	7	9/32	M 5	25	1	8219323

*) special lengths upon request

**Special bits
(not hardened)**

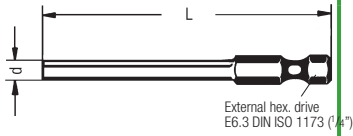

mm	d	in.	mm	L	in.	Part no.
7	.275		70	2 ³ / ₄		490221V
7	.275		102	4		490222V
7	.275		127	5		490223V
7	.275		152	6		490224V
7	.275		200	7 ⁷ / ₈		490225V
7	.275		260	10 ¹ / ₄		490279
7	.275		300	11 ¹³ / ₁₆		490281V
8	.315		300	11 ¹³ / ₁₆		490319V

Adapters

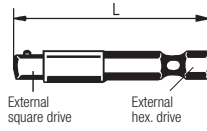

square drive	mm	L	in.	Part no.
1/4"	50	2		804050
1/4"	76	3		8036471
1/4"	100	3 ¹⁵ / ₁₆		804051
1/4"	152	6		8038081
1/4"	203	8		8038091
1/4"	254	10		8038101
1/4"	305	12		8038111
1/4"	355	14		8037981
1/4"	406	16		8207661
3/8"	50	2		8040521
3/8"	76	3		8201451
3/8"	100	3 ¹⁵ / ₁₆		803807
3/8"	152	6		8203921
3/8"	254	10		8038051
1/2"	50	2		804053
1/2"	152	6		8200351

Chuck for stud screws

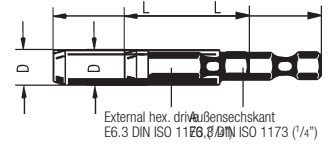
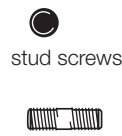

stud screws	mm	D	in.	mm	L	in.	Part no.
M 3	9	1 ¹ / ₃₂		50	2		390287
M 4	9	1 ¹ / ₃₂		50	2		390285
M 5	9	1 ¹ / ₃₂		50	2		390335
M 6	9	1 ¹ / ₃₂		50	2		390288
M 8	16	5/8		55	2 ³ / ₁₆		390295
M 10	16	5/8		55	2 ³ / ₁₆		390339
M 12	16	5/8		55	2 ³ / ₁₆		390338

FOR MINIMAT, RECYCLING, SLIP CLUTCH, PULSE TOOLS, ELECTRIC SCREWDRIVERS

allen screws,
threaded pins



Torx screws



Bits

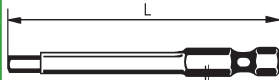

External hex drive
E6.3 DIN ISO 1173 (1/4")
allen bit

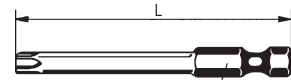

External hex drive
E6.3 DIN ISO 1173 (1/4")
Torx bit

AF mm	AF in.	Torx- size	L = 50 (1 ¹⁵ / ₁₆ "") Part no.	L = 70 (2 ³ / ₄ "") Part no.	L = 50 (1 ¹⁵ / ₁₆ "") Part no.	L = 70 (2 ³ / ₄ "") Part no.	L = 89 (3 ¹ / ₂ "") Part no.	L = 152 (6") Part no.
1.5	.059	—	—	—	—	—	—	—
1.5	.059	T 6	—	—	821092	8215162	8210551	823038
—	—	T 7	—	—	8035351	8035481	8035601	8235201
2	.078	T 8	3248143	327153	803536	8038663	803561	803575
—	—	T 9	—	—	8035371	8035491	8035621	8035761
2	.078	T 10	3248143	327153	8038692	803550	8035631	803868
2.5	.098	T 10	804114	325565	—	—	—	—
—	—	T 15	—	—	8035381	812914	8035641	8035771
2.5	.098	T 20	804114	325565	8035391	812915	8035651	8035781
3	.118	T 20	—	—	—	—	—	—
3	.118	T 25	804115	803975	8035401	812916	8035661	8035791
4	.157	T 25	804116	803976	—	—	—	—
—	—	T 27	—	—	8035411	812917	8229951	8035801
4	.157	T 30	804116	803976	8035421	812918	8035681	8035811
5	.195	T 30	—	—	—	—	—	—
5	.195	T 40	804117	803977	8035431	803556	8035691	8035821
6	.234	T 40	804118	803978	—	—	—	—
8	.312	—	803678	8129283	—	—	—	—

FOR SENSOMAT, MINIMAT-T SCREWDRIVERS

 slotted screws
(only self tapping screws)

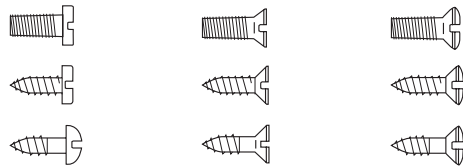

	head dia.	
	mm	in.
	3.8	.150
	4	.157
	4.3	.170
	4.5	.177
	4.7	.185
	5	.196
	5.6	.220
	6	.236
	6.5	.255
	6.9	.271
	7	.275
	7	.275
	7.5	.295
	8	.315
	8.2	.323
	8.3	.326
	8.5	.334
	9	.354

 PHILLIPS screws
(only drilling and self tapping screws)

 POZIDRIV screws
(only drilling and self tapping screws)

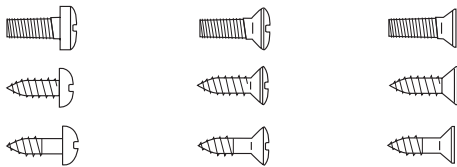

Sensor sleeves, bits

counter nut for above with finders (and spring sleeve),
without and with screw suction*)

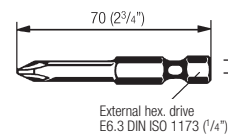
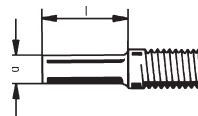

point size	head dia.		d				sensor sleeves Part no.	bit		Part no.
	mm	in.	mm	in.	mm	in.		PHILLIPS Part no.	POZIDRIV Part no.	
1	3.8	.150	6	.24	17	11/16	346070			counter nut 339983 (f. SENSOMAT) 3399831 (f. MINIMAT-T)
1	4	.157	6	.24	17	11/16	346071	338894	339140	
1	4.3	.170	6	.24	17	11/16	346072			
1	4.7	.185	6.5	.26	17	11/16	—			
1	5	.196	7	.28	17	11/16	346089	804046	803988	
1	5.6	.220	7.5	.30	17	11/16	346090			
1	6	.236	8	.31	17	11/16	346091			
2	6.5	.255	8.5	.33	17	11/16	346092	804047	803989	
2	6.9	.271	9	.35	17	11/16	346093			
2	7	.275	9	.35	17	11/16	346094			
2	7.5	.295	9	.35	17	11/16	346095			
2	8	.315	10	.39	20	13/16	346096			
2	8.2	.323	10	.39	20	13/16	346084			
2	8.3	.326	10	.39	20	13/16	346097			
2	9	.354	11	.43	12	15/32	346098			
2	9.2	.362	11	.43	12	15/32	346099			
2	9.5	.374	11.5	.45	12	15/32	346100			

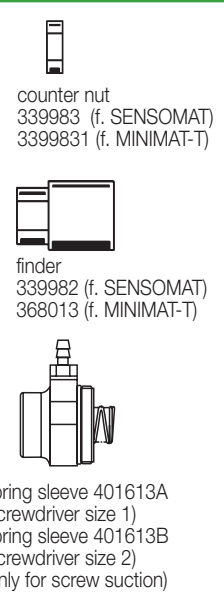

*) Screw suction for drilling and self tapping screws not recommendable

Sensor sleeves, bits

counter nut for above with finders, without screw suction

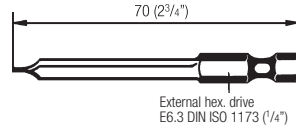
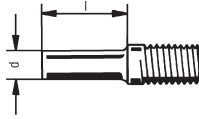

d		l		sensor sleeves Part no.	blade		bit Part no.	counter nut Part no.	finder Part no.
mm	in.	mm	in.		mm	in.			
6	.24	17	11/16	346070	0.5 x 3	.020 x .122	804021	339983 (f. SENSOMAT)	339982 (f. SENSOMAT)
6	.24	17	11/16	346071	0.5 x 3	.020 x .122			
6	.24	17	11/16	346072	0.5 x 3	.020 x .122			
6.5	.26	17	11/16	346073	0.5 x 3	.020 x .122			
6.5	.26	17	11/16	—	0.5 x 3	.020 x .122			
7	.28	17	11/16	346075	0.5 x 3	.020 x .122			
7.5	.30	17	11/16	346076	0.8 x 4	.032 x .154			
8	.31	17	11/16	346077	0.8 x 4	.032 x .154			
8.5	.33	17	11/16	346078	0.8 x 4	.032 x .154			
9	.35	17	11/16	346079	1.0 x 5.5	.038 x .215			
9	.35	17	11/16	346080	0.8 x 4.0	.032 x .154	803595		
9	.35	17	11/16	346081	1.0 x 5.5	.038 x .215	803596		
9	.35	17	11/16	346082	1.0 x 5.5	.038 x .215			
10	.39	20	13/16	346083	1.0 x 5.5	.038 x .215			
10	.39	20	13/16	346084	1.2 x 6.5	.046 x .255	803873		
10	.39	20	13/16	346085	1.0 x 5.5	.038 x .215	803596		
10	.39	20	13/16	346086	1.2 x 6.5	.046 x .255	803873		
11	.43	12	15/32	346087	1.0 x 5.5	.038 x .215	803596		

Sensor sleeves, bits, bit holder (magnetic)

counter nut for above with finders, without screw suction

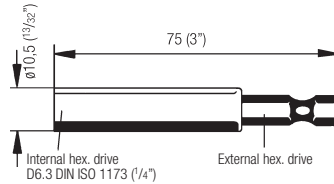
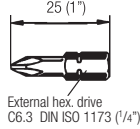

d		l		sensor sleeves Part no.	bit		bit holder (magnetic) Part no.	counter nut Part no.	finder Part no.
mm	in.	mm	in.		PHILLIPS Part no.	POZIDRIV Part no.			
7	.28	7	.28	344123	804636	804665	821068	343982 (f. SENSOMAT)	343981 (f. SENSOMAT)
7	.28	7	.28						
7	.28	7	.28						
7	.28	7	.28						
7	.28	7	.28						
8	.31	8	.31	344124	804636	804665			
8	.31	8	.31						
10	.39	8	.31	343983	804636	804665			
10	.39	8	.31						
10	.39	8	.31						
11.5	.45	8	.31	344125	804637	804666			
11.5	.45	8	.31						
11.5	.45	8	.31						
12.5	.49	8	.31	344126	804637	804666			
12.5	.49	8	.31						
12.5	.49	8	.31						

FOR RATCHET WRENCH

hex. screws hex. nuts		Sockets with hexagon		Closed Head	
		39-521-19 K			39-331-46 K
AF mm	AF in.	Part no.		Part no.	
5	—	4014678		—	
5.5	7/32	4014677		—	
7	—	4014675		—	
8	5/16	4014674		—	
10	—	4014672		—	
11	—	—		804154	
12	—	—		804155	
13	—	—		—	
14	—	—		—	
15	—	—		—	
16	5/8	—		—	
17	—	—		804157	
18	—	—		—	
19	3/4	—		804158	
22	—	—		804159	
24	—	—		402717	
27	1 1/16	—		804161	
1/2"	—	—		804165	
5/8"	—	—		—	

In-between sizes with hexagon and sockets with square on request

hex. screws hex. nuts		Sockets, Holder		Closed Head				
		39-331-32 K	39-331-32 L	39-331-46 K				
AF mm	AF in.	D mm	D in.	L mm	L in.	Socket Part no.	Socket Part no.	Holder (for socket AF 14) Part no.
10	—	25	1	40	1 9/16	804392	—	804245
13	—	25	1	40	1 9/16	804393	804393	804245
16	5/8	30	1 3/16	38	1 1/2	820293	820293	804245
17	—	30	1 3/16	40	1 9/16	804394	804394	804245
18	—	30	1 3/16	38	1 1/2	820294	820294	804245
19	3/4	30	1 3/16	40	1 9/16	804395	804395	804245
21	—	30	1 3/16	38	1 1/2	—	820526	804245
22	—	32.5	1 9/32	40	1 9/16	—	804396	804245
24	—	35	1 3/8	45	1 49/64	—	804397	804245
27	1 1/16	38.5	1 39/64	50	1 31/32	—	804398	804245

FOR MINIMAT, RECYCLING-, SLIP CLUTCH-, PULSE TOOLS, ELECTRIC SCREWDRIVER

hex. screws hex. nuts		Sockets with shaft 1/4" hex. drive						
AF mm	AF in.	D mm	D in.	Part no.	Part no.	D mm	D in.	Part no.
5	—	10	25/64	804126	804135	8.5	11/32	325363
5.5	7/32	10	25/64	804120	804130	9.5	3/8	325153
6	—	10	25/64	804125	804128	9.5	3/8	325421
7	—	12	15/32	804121	804131	10	25/64	324914
8	5/16	13	1/2	804122	804132	11.5	29/32	325052
9	—	14	9/16	804113	804152	13	1/2	335024
10	—	16	5/8	804123	804133	13	1/2	325053
11	—	15.5	39/64	804127	804129	—	—	—
12	—	16.5	21/32	803791	804111	—	—	—
13	—	19	3/4	804124	804134	—	—	—

FOR MINIMAT, RECYCLING, SLIP CLUTCH, PULSE TOOLS, ELECTRIC SCREWDRIVER, IMPACT WRENCHES, EC-SERVO SCREWDRIVER

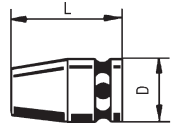

Sockets with female square drive

hex. screws hex. nuts														short execution, non-magnetic and magnetic													
Internal square drive G 6.3 DIN 3121 (1/4")								Internal square drive G 10 DIN 3121 (3/8")								Internal square drive G 12.5 DIN 3121 (1/2")											
AF mm	AF in.	D mm	D in.	L mm	L in.	non-magnetic Part no.	magnetic Part no.	D mm	D in.	L mm	L in.	non-magnetic Part no.	magnetic Part no.	D mm	D in.	L mm	L in.	non-magnetic Part no.	magnetic Part no.								
5	—	13	1/2	25	1	804056	804086	—	—	—	—	—	—	—	—	—	—	—	—								
5.5	7/32	13	1/2	23	29/32	804057	804087	—	—	—	—	—	—	—	—	—	—	—	—								
6	—	13	1/2	23	29/32	804058	804088	—	—	—	—	—	—	—	—	—	—	—	—								
7	—	13	1/2	23	29/32	804059	804089	19	3/4	34	1 11/32	804370	820851	—	—	—	—	—	—								
8	5/16	13	1/2	23	29/32	804060	804090	19	3/4	34	1 11/32	804371	820852	25	1	40	1 9/16	804391	820861								
9	—	13.5	17/32	23	29/32	804061	804091	19	3/4	34	1 11/32	820853	820854	25	1	40	1 9/16	820862	820863								
10	—	15	19/32	23	29/32	804062	—	19	3/4	34	1 11/32	804372	803768	25	1	40	1 9/16	804392	820864								
10	—	15.9	5/8	25.4	1	—	8040921	—	—	—	—	—	—	—	—	—	—	—	—								
11	—	16	5/8	23	29/32	804063	804093	19	3/4	34	1 11/32	820855	820856	25	1	40	1 9/16	803766	820865								
12	—	17.5	11/16	23	29/32	804064	8040941	19	3/4	34	1 11/32	820295	820857	25	1	40	1 9/16	820175	820866								
13	—	19	3/4	23	29/32	804065	804095	22	7/8	34	1 11/32	804373	820858	25	1	40	1 9/16	804393	820244								
16	5/8	—	—	—	—	—	—	24.5	31/32	34	1 11/32	820292	820859	25	1	40	1 9/16	820293	820867								
17	—	—	—	—	—	—	—	25.5	1	34	1 11/32	804374	812942	30	1 3/16	40	1 9/16	804394	812923								
18	—	—	—	—	—	—	—	26.5	1 3/64	34	1 11/32	820311	820860	30	1 3/16	40	1 9/16	820294	820541								
19	3/4	—	—	—	—	—	—	28	1 3/32	34	1 11/32	804375	820711	30	1 3/16	40	1 9/16	804395	812925								
21	—	—	—	—	—	—	—	—	—	—	—	—	—	—	—	—	—	—	—								
22	—	—	—	—	—	—	—	—	—	—	—	—	—	32	1 1/4	40	1 9/16	820526	820868								
24	—	—	—	—	—	—	—	—	—	—	—	—	—	33	1 5/16	40	1 9/16	804396	820869								
27	1 1/16	—	—	—	—	—	—	—	—	—	—	—	—	35.5	1 13/32	45	1 25/32	804397	820870								
—	—	—	—	—	—	—	—	—	—	—	—	—	—	40	1 9/16	50	1 31/32	804398	—								

hex. screws hex. nuts														short execution, non-magnetic													
Internal square drive G 16 DIN 3121 (5/8")					Internal square drive H 20 DIN 3121 (3/4")					Internal square drive H 25 DIN 3121 (1")					Internal square drive H 40 DIN 3121 (1 1/2")					Internal square drive H 63 DIN 3121 (2 1/2")							
AF mm	AF in.	D mm	D in.	L mm	L in.	Part no.	D mm	D in.	L mm	L in.	Part no.	D mm	D in.	L mm	L in.	Part no.	D mm	D in.	L mm	L in.	Part no.	D mm	D in.	L mm	L in.	Part no.	
13	—	35	1 3/8	48	1 5/8	803885	—	—	—	—	—	—	—	—	—	—	—	—	—	—	—	—	—	—	—	—	
16	5/8	35	1 3/8	48	1 5/8	820527	—	—	—	—	—	—	—	—	—	—	—	—	—	—	—	—	—	—	—	—	
17	—	35	1 3/8	48	1 5/8	803886	44	1 47/64	50	1 31/32	804410	—	—	—	—	—	—	—	—	—	—	—	—	—	—	—	
18	—	35	1 3/8	48	1 5/8	820528	44	1 47/64	50	1 31/32	820530	—	—	—	—	—	—	—	—	—	—	—	—	—	—	—	
19	3/4	35	1 3/8	48	1 5/8	803887	44	1 47/64	50	1 31/32	804411	—	—	—	—	—	—	—	—	—	—	—	—	—	—	—	
21	—	35	1 3/8	48	1 5/8	820529	44	1 47/64	50	1 31/32	820531	—	—	—	—	—	—	—	—	—	—	—	—	—	—	—	
22	—	35	1 3/8	48	1 5/8	803888	44	1 47/64	50	1 31/32	804412	—	—	—	—	—	—	—	—	—	—	—	—	—	—	—	
24	—	37	1 29/64	50	1 47/64	803889	44	1 47/64	50	1 31/32	804413	—	—	—	—	—	—	—	—	—	—	—	—	—	—	—	
27	1 1/16	40.5	1 19/32	50	1 31/32	803890	44	1 47/64	50	1 31/32	804414	54	2 1/8	60	2 23/64	804430	—	—	—	—	—	—	—	—	—	—	
30	—	—	—	—	—	—	46	1 13/16	54	2 1/8	804415	54	2 1/8	63	2 31/64	804431	—	—	—	—	—	—	—	—	—	—	
32	1 1/4	—	—	—	—	—	49	1 15/16	53	2 3/32	804416	54	2 1/8	62	2 7/16	804432	—	—	—	—	—	—	—	—	—	—	
34	—	—	—	—	—	—	51	2 1/64	55	2 11/64	820532	54	2 1/8	62	2 7/16	820533	—	—	—	—	—	—	—	—	—	—	
36	—	—	—	—	—	—	54	2 1/8	58	2 9/32	804417	57	2 1/4	62	2 7/16	804433	—	—	—	—	—	—	—	—	—	—	
41	—	—	—	—	—	—	60	2 23/64	58	2 9/32	804418	63	2 31/64	66	2 19/32	804434	—	—	—	—	—	—	—	—	—	—	
46	1 13/16	—	—	—	—	—	66	2 39/64	58	2 9/32	804419	69.5	2 47/64	70	2 3/4	804435	86	3 25/64	84	3 5/16	804450	—	—	—	—		
50	1 31/32	—	—	—	—	—	—	—	—	—	—	74.5	2 15/16	70	2 3/4	804436	86	3 25/64	84	3 5/16	804451	—	—	—	—		
55	—	—	—	—	—	—	—	—	—	—	—	81	3 3/16	85	3 11/32	804437	87	3 27/64	90	3 35/64	804452	—	—	—	—		
60	—	—	—	—	—	—	—	—	—	—	—	87.5	3 7/16	85	3 11/32	804438	93	3 21/32	90	3 35/64	804453	—	—	—	—		
65	2 9/16	—	—	—	—	—	—	—	—	—	—	—	—	—	—	—	99	3 57/64	95	3 47/64	804454	—	—	—	—		
70	—	—	—	—	—	—	—	—	—	—	—	—	—	—	—	—	106	4 11/64	100	3 15/16	804455	—	—	—	—		
75	2 51/64	—	—	—	—	—	—	—	—	—	—	—	—	—	—	—	112	4 13/32	105	4 9/64	804456	—	—	—	—		
80	—	—	—	—	—	—	—	—	—	—	—	—	—	—	—	—	118	4 41/64	110	4 21/64	804457	—	—	—	—		
85	3 11/32	—	—	—	—	—	—	—	—	—	—	—	—	—	—	—	125	4 59/64	110	4 21/64	804458	—	—	—	—		
90	3 35/64	—	—	—	—	—	—	—	—	—	—	—	—	—	—	—	131	5 5/32	115	4 17/32	804459	—	—	—	—		
95	—	—	—	—	—	—	—	—	—	—	—	—	—	—	—	—	137	5 25/64	120	4 23/32	804460	—	—	—	—		
100	3 15/16	—	—	—	—	—	—	—	—	—	—	—	—	—	—	—	143	5 5/8	125	4 59/64	804461	—	—	—	—		
105	—	—	—	—	—	—	—	—	—	—	—	—	—	—	—	—	150	5 29/32	130	5 1/8	804462	150	5 29/32	140	5 33/64	804480	
110	4 21/64	—	—	—	—	—	—	—	—	—	—	—	—	—	—	—	156	6 9/64	135	5 5/16	804463	156	6 9/64	147	5 25/32	804481	
115	4 17/32	—	—	—	—	—	—	—	—	—	—	—	—	—	—	—	156	6 9/64	135	5 5/16	804463	162	6 3/8	147	5 25/32	804482	
120	—	—	—	—	—	—	—	—	—	—	—	—	—	—	—	—	160	6 19/64	128	5 3/64	825633	169	6 21/32	150	5 29/32	804483	
130	5 1/8	—	—	—	—	—	—	—	—	—	—	—	—	—	—	—	—	—	—	—	—	175	6 57/64	152	5 63/64	804484	
145	—	—	—	—	—	—	—	—	—	—	—	—	—	—	—	—	—	—	—	—	—	188	7 13/32	160	6 19/64	804485	
155	—	—	—	—	—	—	—	—	—	—	—	—	—	—	—	—	—	—	—	—	—	207	8 5/32	170	6 11/16	804486	
—	—	—	—	—	—	—	—	—	—	—	—	—	—	—	—	—	—	—	—	—	—	218	8 37/64	177	6 31/32	804487	

Please order locking pin and rubber ring extra

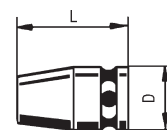
FOR MINIMAT, RECYCLING, SLIP CLUTCH, PULSE TOOLS, ELECTRIC SCREWDRIVER, IMPACT WRENCHES, EC-SERVO SCREWDRIVER

Sockets with internal square drive DIN 3121

hex. screws hex. nuts		long execution, non-magnetic														
		Internal square drive G 6.3 DIN 3121 (1/4")					Internal square drive G 10 DIN 3121 (3/8")					Internal square drive G 12.5 DIN 3121 (1/2")				
AF		D		L		Part no.	D		L		Part no.	D		L		Part no.
mm	in.	mm	in.	mm	in.		mm	in.	mm	in.		mm	in.	mm	in.	
7	—	13	1/2	45	1 3/4	8037671	—	—	—	—	—	—	—	—	—	—
8	5/16	13	1/2	45	1 3/4	8037591	19	3/4	51	2	820872	25	1	85	3 11/32	804400
9	—	14.5	9/16	45	1 3/4	8204461	19	3/4	51	2	820873	—	—	—	—	—
10	—	16	5/8	45	1 3/4	8037601	19	3/4	51	2	820874	25	1	85	3 11/32	804401
11	—	16	5/8	45	1 3/4	8207851	19	3/4	51	2	820875	—	—	—	—	—
12	—	17.5	11/16	45	1 3/4	8201011	19	3/4	51	2	820876	—	—	—	—	—
13	—	19	3/4	45	1 3/4	8129311	22	7/8	51	2	820877	25	1	85	3 11/32	804402
16	5/8	—	—	—	—	—	24.5	31/32	51	2	820878	30	1 3/16	80	3 5/32	820534
17	—	—	—	—	—	—	25.5	1	51	2	820879	30	1 3/16	85	3 11/32	804403
18	—	—	—	—	—	—	26.5	1 3/64	51	2	820880	30	1 3/16	80	3 5/32	820535
19	3/4	—	—	—	—	—	28	1 3/32	51	2	820881	30	1 3/16	80	3 5/32	804404
21	—	—	—	—	—	—	—	—	—	—	—	30	1 3/16	80	3 5/32	820536
22	—	—	—	—	—	—	—	—	—	—	—	32.5	1 9/32	85	3 11/32	804405
24	—	—	—	—	—	—	—	—	—	—	—	35	1 3/8	85	3 11/32	804406
27	1 1/16	—	—	—	—	—	—	—	—	—	—	38.5	1 33/64	85	3 11/32	804407

hex. screws hex. nuts		long execution, non-magnetic																			
		Internal square drive G 16 DIN 3121 (5/8")				Internal square drive H 20 DIN 3121 (1")				Internal square drive H 25 DIN 3121 (1 1/2")				Internal square drive H 40 DIN 3121 (1 1/2")							
AF		D		L		Part no.	D		L		Part no.	D		L		Part no.	D		L		Part no.
mm	in.	mm	in.	mm	in.		mm	in.	mm	in.		mm	in.	mm	in.		mm	in.	mm	in.	
17	—	35	1 3/8	90	3 5/8	803891	44	1 47/64	100	3 15/16	804420	—	—	—	—	—	—	—	—	—	—
18	—	—	—	—	—	—	—	—	—	—	—	—	—	—	—	—	—	—	—	—	—
19	3/4	35	1 3/8	90	3 5/8	803892	44	1 47/64	100	3 15/16	804421	—	—	—	—	—	—	—	—	—	—
21	—	—	—	—	—	—	44	1 47/64	100	3 15/16	820537	—	—	—	—	—	—	—	—	—	—
22	—	35	1 3/8	90	3 5/8	803893	44	1 47/64	100	3 15/16	804422	—	—	—	—	—	—	—	—	—	—
24	—	37	1 29/64	90	3 35/64	803894	44	1 47/64	100	3 15/16	804423	54	2 1/8	110	4 21/64	820067	—	—	—	—	—
27	1 1/16	40.5	1 19/32	90	3 35/64	803895	44	1 47/64	100	3 15/16	804424	54	2 1/8	110	4 21/64	804440	—	—	—	—	—
30	—	—	—	—	—	—	46	1 13/16	100	3 15/16	804425	54	2 1/8	110	4 21/64	804441	—	—	—	—	—
32	1 1/4	—	—	—	—	—	49	1 15/16	100	3 15/16	804426	54	2 1/8	110	4 21/64	804442	—	—	—	—	—
34	—	—	—	—	—	—	51	2 1/64	100	3 15/16	820538	54	2 1/8	108	4 1/4	820539	—	—	—	—	—
36	—	—	—	—	—	—	54	2 1/8	100	3 15/16	804427	57	2 1/4	108	4 1/4	804443	—	—	—	—	—
41	—	—	—	—	—	—	60	2 23/64	100	3 15/16	804428	63	2 31/64	108	4 1/4	804444	—	—	—	—	—
46	1 13/16	—	—	—	—	—	67	2 41/64	100	3 15/16	804429	69.5	2 47/64	110	4 21/64	804445	86	3 25/64	130	5 1/8	804465
50	1 31/32	—	—	—	—	—	—	—	—	—	—	74.5	2 15/16	115	4 17/32	804446	86	3 25/64	140	5 33/64	804466
55	—	—	—	—	—	—	—	—	—	—	—	81	3 3/16	115	4 17/32	804447	87	3 27/64	140	5 33/64	804467
60	—	—	—	—	—	—	—	—	—	—	—	87.5	3 7/16	115	4 17/32	804448	93	3 21/32	140	5 33/64	804468
65	2 9/16	—	—	—	—	—	—	—	—	—	—	—	—	—	—	—	99	3 57/64	150	5 29/32	804469
70	—	—	—	—	—	—	—	—	—	—	—	—	—	—	—	—	106	4 11/64	150	5 29/32	804470
75	2 61/64	—	—	—	—	—	—	—	—	—	—	—	—	—	—	—	112	4 13/32	160	6 19/64	804471
80	—	—	—	—	—	—	—	—	—	—	—	—	—	—	—	—	118	4 41/64	170	6 11/16	804472
85	3 11/32	—	—	—	—	—	—	—	—	—	—	—	—	—	—	—	125	4 59/64	170	6 11/16	804473
90	3 35/64	—	—	—	—	—	—	—	—	—	—	—	—	—	—	—	131	5 5/32	180	7 3/32	804474
95	—	—	—	—	—	—	—	—	—	—	—	—	—	—	—	—	137	5 25/64	180	7 3/32	804475
100	3 15/16	—	—	—	—	—	—	—	—	—	—	—	—	—	—	—	143	5 5/8	190	7 31/64	804476
105	—	—	—	—	—	—	—	—	—	—	—	—	—	—	—	—	150	5 29/32	200	7 7/8	804477
110	4 21/64	—	—	—	—	—	—	—	—	—	—	—	—	—	—	—	156	6 9/64	200	7 7/8	804478

Please order locking pin and rubber ring extra



Extensions with internal square drive DIN 3121

Internal-□ External-□	G 10 DIN 3121 (3/8")		G 12.5 DIN 3121 (1/2")		G 16 DIN 3121 (5/8")		H 20 DIN 3121 (1")		H 25 DIN 3121 (1 1/2")		H 40 DIN 3121 (1 1/2")														
	E 10 DIN 3121 (3/8")		E 12.5 DIN 3121 (1/2")		E 16 DIN 3121 (5/8")		F 20 DIN 3121 (1")		F 25 DIN 3121 (1 1/2")		F 40 DIN 3121 (1 1/2")														
	D	L	D	L	D	L	D	L	D	L	D	L													
	mm	in.	mm	in.	Part no.	mm	in.	mm	in.	Part no.	mm	in.	mm	in.	Part no.										
	19	3/4	75	2 61/64	804490	25	63/64	75	2 61/64	804493	44	1 47/64	175	6 27/64	804497	54	2 1/8	175	6 57/64	804501	86	3 25/64	250	9 27/32	804505
	19	3/4	150	5 29/32	804491	25	63/64	125	4 59/64	804494	44	1 47/64	250	9 27/32	804498	54	2 1/8	250	9 27/32	804502	86	3 25/64	380	14 31/32	804506
	19	3/4	300	11 13/16	804492	25	63/64	250	9 27/32	804495	44	1 47/64	330	13	804499	54	2 1/8	330	13	804503	—	—	—	—	—

Please order locking pin and rubber ring extra

internal hex. screws		Bits			Holder						
threaded pins with internal hex.		external hex. drive			Internal hex. drive / Internal square drive						
AF mm	AF in.	7/16" L = 35 mm = 1 3/8 in. Part no.	5/8" L = 40 mm = 1 37/64 in. Part no.	7/8" L = 50 mm = 1 31/32 in. Part no.	internal square drive DIN 3121	internal hex. drive	D mm	D in.	L mm	L in.	Part no.
3	1/8	804525									
4	—	804526									
5	—	804527									
6	—	804528	—								
6	—	820046									
7	—	804529									
8	5/16	804530	804533	—							
10	—	804531	804534		G 10 (3/8")	7/16" (11.1 mm)	22	55/64	32	1 1/4	804520
12	—	804532	804535		G 12.5 (1/2")	7/16" (11.1 mm)	30	1 3/16	38	1 1/2	804521
12	—	820215	804536		H 20 (3/4")	5/8" (15.9 mm)	44	1 47/64	52	2 3/64	804522
14	—	—	—		H 20 (3/4")	7/8" (22 mm)	44	1 47/64	60	2 23/64	804519
14	—	—	—		H 25 (1")	5/8" (15.9 mm)	54	2 1/8	68	2 43/64	8045231
17	—	—	—		H 25 (1")	7/8" (22 mm)	54	2 1/8	70	2 3/4	804524
17	—	—	—	804537							
19	3/4	—	—	804541							
19	3/4	—	—	804542							
22	—	—	—	804619							
24	—	—	—	804574							
27	1 1/16	—	—	804618							
32	—	—	—								
36	—	—	—								

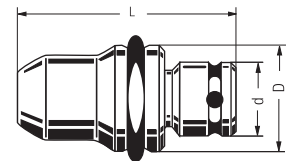
Please order locking pin and rubber ring extra



Chuck for stud screws with internal square drive DIN 3121

Thread size	Internal square drive G 10 DIN 3121 (3/8")						Internal square drive G 12.5 DIN 3121 (1/2")						Internal square drive H 20 DIN 3121 (3/4")									
	D mm	D in.	d mm	d in.	L mm	L in.	Part no.	D mm	D in.	d mm	d in.	L mm	L in.	Part no.	D mm	D in.	d mm	d in.	L mm	L in.	Part no.	
M 5	35	1 3/8	22	55/64	65	2 9/16	790025B	—	—	—	—	—	—	—	—	—	—	—	—	—	—	—
M 6	35	1 3/8	22	55/64	65	2 9/16	790025C	—	—	—	—	—	—	—	—	—	—	—	—	—	—	—
M 8	35	1 3/8	22	55/64	65	2 9/16	790025D	47	1 27/32	28	1 7/64	79	3 7/64	390203A	—	—	—	—	—	—	—	—
M 10	35	1 3/8	22	55/64	65	2 9/16	790025E	47	1 27/32	28	1 7/64	84	3 5/16	390203B	—	—	—	—	—	—	—	—
M 12	—	—	—	—	—	—	—	47	1 27/32	28	1 7/64	84	3 5/16	390203C	—	—	—	—	—	—	—	—
M 14	—	—	—	—	—	—	—	47	1 27/32	28	1 7/64	84	3 5/16	390203D	60	2 25/64	41	1 39/64	95	3 47/64	390135A	
M 16	—	—	—	—	—	—	—	47	1 27/32	28	1 7/64	84	3 5/16	390203E	60	2 25/64	41	1 39/64	95	3 47/64	390135B	
M 18	—	—	—	—	—	—	—	—	—	—	—	—	—	—	60	2 25/64	41	1 39/64	95	3 47/64	390135C	
M 20	—	—	—	—	—	—	—	—	—	—	—	—	—	—	60	2 25/64	41	1 39/64	95	3 47/64	390135D	
M 22	—	—	—	—	—	—	—	—	—	—	—	—	—	—	60	2 25/64	41	1 39/64	95	3 47/64	390135E	
M 24	—	—	—	—	—	—	—	—	—	—	—	—	—	—	60	2 25/64	41	1 39/64	95	3 47/64	390135F	
M 27	—	—	—	—	—	—	—	—	—	—	—	—	—	—	—	—	—	—	—	—	—	—
M 30	—	—	—	—	—	—	—	—	—	—	—	—	—	—	—	—	—	—	—	—	—	—
M 33	—	—	—	—	—	—	—	—	—	—	—	—	—	—	—	—	—	—	—	—	—	—

Please order locking pin and rubber ring extra

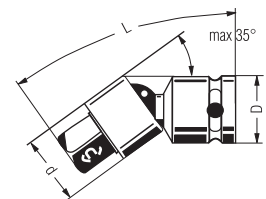

Ball joint with internal square drive DIN 3121

Internal-□	G 6.3 DIN 3121 (1/4")			G 10 DIN 3121 (3/8")			G 12.5 DIN 3121 (1/2")			H 20 DIN 3121 (3/4")			H 25 DIN 3121 (1")			H 40 DIN 3121 (1 1/2")		
External-□	E 6.3 DIN 3121 (1/4")			E 10 DIN 3121 (3/8")			E 12.5 DIN 3121 (1/2")			F 20 DIN 3121 (3/4")			F 25 DIN 3121 (1")			F 40 DIN 3121 (1 1/2")		
	D mm	d mm	L = 43 mm Part no.	D mm	d mm	L = 58 mm Part no.	D mm	d mm	L = 78 mm Part no.	D mm	d mm	L = 95 mm Part no.	D mm	d mm	L = 128 mm Part no.	D mm	d mm	L = 178 mm Part no.
	16	16	804518	22	22	804510	28	28	804511	38	38	804512	53	53	804513	86	86	804514
	5/8	5/8		55/64	55/64		1 1/64	1 1/64		1 1/2	1 1/2		2 3/32	2 3/32		3 25/64	3 25/64	

Please order locking pin and rubber ring extra

FOR IMPACT WRENCHES, PULSE TOOLS, EC-SERVO SCREWDRIVER

Locking pins and rubber rings for sockets, holder, extensions, ball joints and chucks for stud screws

Internal square drive DIN 3121	Sockets		Extension Ball joint Holder		Chuck for stud screws		Locking pin				Rubber ring					
	AF mm	AF in.	mm	D in.	mm	d in.	d mm	d in.	mm	l in.	Part no.	D mm	D in.	d mm	d in.	Part no.
G 10 (3/8")	7-19	3.0	19/22	3/4 / 55/64	22	55/64	2.5	3/32	16	5/8	800078	14	35/64	3	1/8	802513
G 12.5 (1/2")	8-13	3.2	25	63/64	—	—	3	1/8	20	25/32	802348	18	45/64	3	1/8	803370
G 12.5 (1/2")	16-27	3.8	28/30	17/64 / 13/16	28	17/64	3	1/8	24	15/16	800012	20	25/32	4	5/32	802499
G 16 (3/8")	8-27	4.0	35	13/8	—	—	3	1/8	28	17/64	802346	24	15/16	4	5/32	802524
H 20 (3/4")	17-46	4.2	38/44	11/2 / 147/64	41	139/64	4	5/32	32	17/64	800056	34	111/32	5.5	7/32	802546
H 25 (1")	27-60	4.3	54	21/8	54	21/8	5	13/64	45	149/64	804546	42	121/32	7.5	19/64	802547
H 40 (1 1/2")	46-90	4.7	86	325/64	—	—	5	13/64	75	261/64	804547	72	253/64	6.5	17/64	—
H 40 (1 1/2")	95-110	5.0	—	—	—	—	6	1/4	110	421/64	—	114	431/64	10.5	27/64	—
H 63 (2 1/2")	100-155	5.5	—	—	—	—	8	5/16	115	417/32	804548	114	431/64	10.5	27/64	—

FOR IMPACT WRENCHES WITH QUICK CHANGE CHUCK (INTERNAL HEX. DRIVE DIN ISO 1173 F11.2)

Bits

Internal hex. screws	Threaded pins with internal hex. drive	AF mm	AF in.	Part no.
6	—	804516		
8	5/16	804538		
10	—	804539		
10	—	804540		
12	—	804540		
12	—	804540		
14	—	804517		

Holder

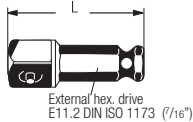
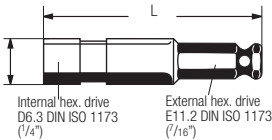
External square drive	L mm / in.	Part no.	for sockets
E 10 DIN 3121 (3/8")	50 / 131/32	8043651	
E 12.5 DIN 3121 (1/2")	54 / 21/8	8043661	
F 20 DIN 3121 (3/4")	76 / 3	8043631	
for bit with external hex. drive C 6.3 DIN ISO 1173 (1/4")			
L mm / in.	D mm / in.	non-magnetic Part no.	
65 / 29/16	11.1 / 7/16	825021	

DEPRAG

DEPRAG SCHULZ GMBH u. CO. KG
P.O. Box 1352 | D-92203 Amberg
Carl-Schulz-Platz 1 | D-92224 Amberg
Phone: +49 9621 371-0 | Fax: +49 9621 371-120
www.deprag.com | info@deprag.de

CERTIFIED AS PER DIN EN ISO 9001